

KATALOG SVÍTIDEL 2020/2021





OBSAH KATEGORIÍ

4-13	INTELIGENTNÍ
14-37	DEKORATIVNÍ
38-67	STROPNÍ A NÁSTĚNNÁ
68-89	BODOVÁ
90-105	STOLNÍ A STOJACÍ
106-121	KOUPELNOVÁ
122-127	KUCHYŇSKÁ
128-149	ZAPUŠTĚNÁ BODOVÁ
150-163	ORIENTAČNÍ
164-187	VENKOVNÍ
188-197	DĚTSKÁ, NÁLADOVÁ
198-219	UŽITKOVÁ, EKONOMY
220-227	VENTILÁTORY
228-229	KONTAKTY

Legenda:

↑ výška [mm] → šířka [mm] ↗ hloubka [mm] ∅ průměr [mm]

Energetická třída:

A++ A+ A A++ E B C D E

* Produkt
skladem 

Čidlo
pohybu 

Stmívání 

Dálkové ovládání
lze dokoupit 

Dálkové
ovládání 

Řetízkové
ovládání 

Tiskové chyby vyhrazeny.

* Skladovost produktů se může v průběhu roku měnit.

LED

STMÍVATELNÁ BÍLÁ

RGB

connect

Bluetooth®

MESH Technology

Available on the
App Store

GET IT ON
Google play

Světlo se ubírá novým směrem: **tvým**

EGLO connect

- nepotřebujete wi-fi ani adaptér
- nastavitelné chytrým telefonem/
tabletem nebo dálkovým ovladačem
- bluetooth s malou spotřebou energie
- bezplatný Android a iOS App
- 2700K teplá bílá - 6500K studená bílá
- výběr z 16 miliónů barev

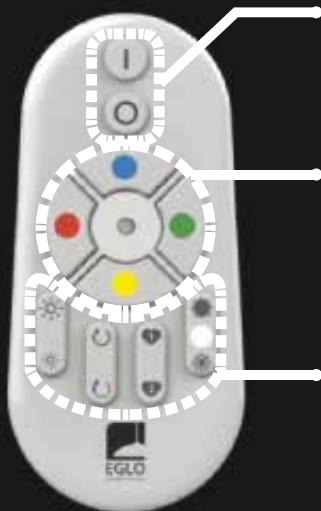

Zapnutí/vypnutí: samostatně
dálkovým ovladačem nebo jeho
zahrnutím do App skupiny.

Krátkým stiskem vyberete požadovanou barvu.
Delší stisknutí - výběr z 16 milionů možností.

Plynulé stmívání (0-100 %),
výběr přechodu barev,
vyvolání oblíbených,
nastavení teploty barvy (2.700K - 6.500K).



Zde naleznete videa
s nápovědou!

► 81793626

↑116 Ø60
9 W/2700–6500 K/806 lm, 230 V, E27, LED, RGB



A+ LED



▼ 81793625



▲ 82287399

↑90 Ø50
5 W/2700–6500 K/400 lm, 230 V, E14, LED, RGB



A+ LED



► 81793627

↑116 Ø60
9 W/2700–6500 K/806 lm, 230 V, E27, LED, RGB



A+ LED



► **81793632**

matný nikl, kov/plast
 ↑30 Ø170
 10,5 W/2700–6500 K/1200 lm, 230 V, IP20, LED, RGB + TW
 montážní otvor ø 155 mm



A+ LED



▲ **81793629**

bílá, kov/plast
 ↑30 Ø120
 5,4 W/2700–6500 K/700 lm, 230 V, IP20, LED, RGB + TW
 montážní otvor ø 108 mm



A++ LED

◀ **81793634**

matný nikl, kov/plast
 ↑30 Ø225
 15,6 W/2700–6500 K/1900 lm, 230 V, IP20, LED, RGB + TW
 montážní otvor ø 207 mm



A+ LED



▲ **81793641**

matný nikl, kov/plast
 ↑40 →225 ↗300
 15,6 W/2700–6500 K/2000 lm, 230 V, IP20, LED, RGB + TW



A+ LED



► **81793638**

bílá, kov/plast
 ↑40 →300 ↗300
 21 W/2700–6500 K/2700 lm, 230 V, IP20, LED, RGB + TW



A+ LED



▲ **81793640**

matný nikl, kov/plast
 ↑40 Ø300
 21 W/2700–6500 K/2700 lm, 230 V, IP20, LED, RGB + TW



A+ LED

► **81793635**

bílá, kov/plast
 ↑30 Ø225
 15,6 W/2700–6500 K/2000 lm, 230 V, IP20, LED, RGB + TW



A+ LED

▶ **81793647**

bílá/chrom, kov/plast

↑70 Ø340

17 W/2700–6500 K/2100 lm, 230 V, IP20, LED, RGB



A++ A LED

▶ **81793648**

bílá, kov/plast

↑90 Ø300

17 W/2700–6500 K/2100 lm, 230 V, IP20, LED, RGB



A++ A LED

▲ **82198992**

matný nikl, hliník

↑125 →1050 ↗120

17 W/2700–6500 K/4600 lm, 230 V, IP20, LED, RGB



A++ A LED

▶ **81793645**

bílá/noční obloha, kov/plast

↑95 Ø380

17 W/2700–6500 K/2100 lm, 230 V, IP20, LED, RGB



A++ A LED

▼ **82198996**

bílá, ocel

↑135 Ø595

34 W/2700–6500 K/5400 lm, 230 V, IP20, LED, RGB



A++ A LED

▲ **81793644**

bílá/stříbrná/průhledná, kov/plast

↑90 Ø430

17 W/2700–6500 K/2100 lm, 230 V, IP20, LED, RGB



A++ A LED



PHILIPS

hue personal wireless lighting



Objevte váš domov v inteligentním světle

Vaše osobní bezdrátové osvětlení, které vám umožní snadno ovládat světlo z vašeho zařízení a vytvářet správné prostředí pro každý okamžik. Objevte nejpropojenější osvětlení na světě. Změní způsob, jakým používáte světlo.

Philips Hue LED žárovky a svítidla

Hue Bridge bezdrátově propojuje vaše chytré zařízení, s Hue svítidly. Systém Philips Hue můžete ovládat z libovolného zařízení, ať jste kdekoli. Nejjednodušší způsob, jak nastavit jas, vytvářet časovače, měnit barvy, je pomocí výběru v aplikaci Philips Hue, nebo Hue dimmer switch.

Inteligentní bezdrátový systém Philips Hue je založen na technologii ovládání světel ZigBee LightLink, která je nízkoenergetická, bezpečná a spolehlivá. Systém Philips Hue lze snadno integrovat s jinými zařízeními pracujícími se ZigBee pro další automatizaci vašeho domu. K jednomu bridge zařízení, lze přidat až 50 Philips Hue svítidel a příslušenství.

Lehká instalace ve 4 jednoduchých krocích



1. Nainstalujte žárovky



2. Připojte bridge



3. Stáhněte si aplikaci



4. Hrajte si a užívejte světlo

White



White Ambiance



White and Color Ambiance



Philips Hue vás uvítá doma a umožňuje vám ovládat osvětlení z ložnice nebo i ze zahrady. Dokonce lze zajistit, že to bude vypadat, jako když jste doma, i když nejste. Jde především o to zjednodušit vám život.

Vytvořte správnou atmosféru pro každý okamžik. Philips Hue vás může přirozeně probudit, pomůže vám načerpat energii, číst, soustředit se, relaxovat nebo dokonce usnout.

Proměňte každodenní osvětlení na mimořádné zážitky. Hrajte si s barvami nebo synchronizujte inteligentní světla se svou hudbou, hrami a filmy. Vybírat můžete ze stovek aplikací a jediným omezením je tak vaše představivost.

▼ **81775652**

2x 9,5 W/2700 K/800 lm, 230 V, IP20, E27, LED



A+ LED



► **81755767**

bílá, plast
↑88 →88 ↗26



◀ **81773350**

9,5 W/2200–6500 K/806 lm, 230 V, IP20, E27, LED



A+ LED



◀ **81887429**

3x 10 W/2000–6500 K/806 lm, 230 V, IP20, E27, LED, RGB



A+ LED





◀ **81890697**

černá, kov/plast
 ↑50 Ø 350
 32 W/2200–6500 K/2400 lm, 230 V, IP20, LED



A+ LED



◀ **81890698**

matný chrom, kov/plast
 ↑50 Ø 350
 32 W/2200–6500 K/2400 lm, 230 V, IP20, LED



A+ LED

▼ **81771463**

černá, kov/plast
 ↑98 Ø 444
 39 W/2200–6500 K/3000 lm, 230 V, IP20, LED



A+ LED



▲ **81771577**

bílá, kov/plast
 ↑50 Ø 350
 32 W/2200–6500 K/2400 lm, 230 V, IP20, LED



A+ LED

▶ **81771462**

bílá, kov/plast
 ↑98 Ø 444
 39 W/2200–6500 K/3000 lm, 230 V, IP20, LED



A+ LED



▶ **81771464**

bílá, kov/plast
 ↑1500 Ø 444
 39 W/2200–6500 K/3000 lm, 230 V, IP20, LED



A+ LED



◀ **81771465**

černá, kov/plast
 ↑1500 Ø 444
 39 W/2200–6500 K/3000 lm, 230 V, IP20, LED



A+ LED

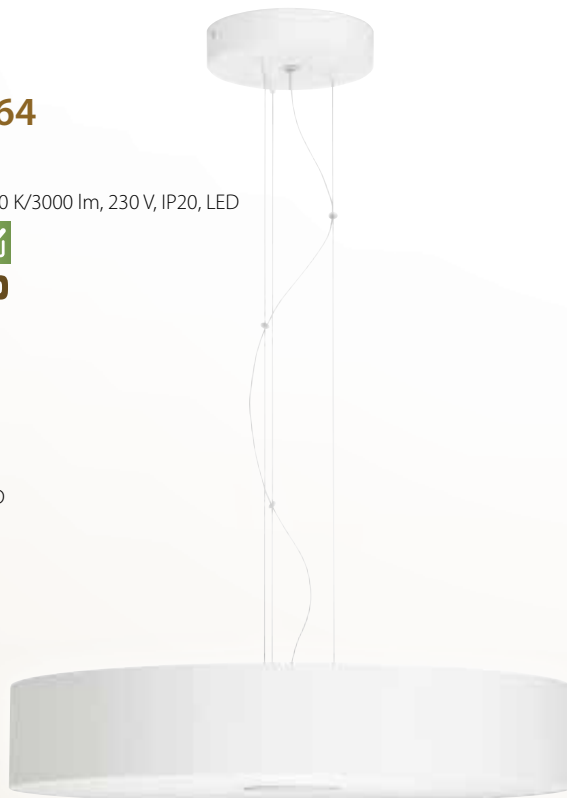



◀ **82287718**

lesklý chrom, kov/plast
 ↑60 Ø405
 40 W/2200–6500 K/2400 lm, 230 V, IP44, LED



▶ **81774765**

černá, kov/plast
 ↑71 Ø391
 32 W/2200–6500 K/2400 lm, 230 V, IP20, LED



▶ **82293914**

bílá, kov/plast
 ↑1400 Ø434
 39 W/2200–6500 K/3000 lm, 230 V, IP20, LED



▲ **82297972**

černá, plast
 ↑36 →253 ↗44
 2200–6500 K/2x 530 lm, 230 V, IP20, LED, RGB



◀ **81790411**

stříbrná, kov/plast
 ↑71 Ø391
 32 W/2200–6500 K/2400 lm, 230 V, IP20, LED



▼ **82287716**

lesklý chrom, kov/plast
 ↑64 →595 ↗131
 40 W/2200–6500 K/3000 lm, 230 V, IP44, LED



▲ **81774367**

bílá, kov/plast
 ↑71 Ø391
 32 W/2200–6500 K/2400 lm, 230 V, IP20, LED





immax
neo
Intelligent friendly light



SEZNAMTE SE!

Toto je Inteligentní řízení domácnosti Immax NEO

DESIGNOVÁ SVĚTLA

Z naší nabídky designových interiérových světel si vybere opravdu každý.

STARTOVACÍ BALÍČKY

Nejjednodušší způsob jak začít. Obsahují LED žárovky, LED pásy, dálkové ovládání a srdce celého systému Bridge + Alarm HUB.

ŽÁROVKY A LED PÁSKY

LED žárovky Immax Neo vyrábíme pro patice E27, E14 a GU10 a můžete si vybrat ze stmívatelné (CCT) nebo barevné varianty (RGB).

ZABEZPEČENÍ

Zabezpečte svou domácnost pomocí díky celé škále výrobků Immax Neo security.

PŘÍSLUŠENSTVÍ

Prozkoumejte originální příslušenství Immax Neo a doved'te svou domácnost k dokonalosti.

Kompatibilní s



PÁNEM SVĚTLA JSTE VY!

Systém Immax Neo je postaven na ověřené technologii ZigBee, která představuje to nejpokrokovější řešení v oblasti chytré domácnosti. Je navržena tak, aby byla schopna propojit výhledově všechna zařízení domácí elektroniky do jednoho jednoduše ovladatelného komplexu.





▶ 82387508

matná bílá, kov/plast
 ↑1200 →600 ↗600
 47 W/2700–6500 K/2152 lm, 230 V, IP 20, LED



A+ LED

◀ 82387507

matná černá, kov/plast
 ↑1200 →450 ↗450
 36 W/2700–6500 K/1800 lm, 230 V, IP 20, LED



A+ LED



▼ 82387502

matná černá, kov/plast
 ↑100 ø 800
 65 W/2700–6500 K/4100 lm, 230 V, IP 20, LED



A+ LED



▲ 82387495

matná bílá, kov/plast
 ↑100 ø 600
 50 W/2700–6500 K/3300 lm, 230 V, IP 20, LED



A+ LED



▼ 82387510

matná bílá, kov
 ↑80 →1185 ↗15
 18 W/2700–6500 K/1260 lm, 230 V, IP 20, LED



A+ LED



▲ 82387511

matná černá, kov
 →1200 ↗30
 42 W/2700–6500 K/2300 lm, 230 V, IP 20, LED



A+ LED



▼ **82383647**

černá/hnědá, ocel/dřevo

↑1100 →700 ↗105

4x 60 W, 230 V, IP20, E27

A++ E





◀ 82394035

šedá/bílá, kov/textil/plast

↑120 Ø980

80 W/3000–5000 K/7800 lm, 230 V, IP20, LED



A++ A LED

▶ 82290670

hnědá/bílá, kov/textil/plast

↑120 Ø760

60 W/3000–5000 K/5800 lm, 230 V, IP20, LED



A++ A LED



◀ 82287447

bílá, kov/textil/plast

↑120 Ø570

40 W/3000–5000 K/4000 lm, 230 V, IP20, LED



A++ A LED

▶ 82289634

šedohnědá/bílá, kov/textil/plast

↑120 Ø760

60 W/3000–5000 K/5800 lm, 230 V, IP20, LED



A++ A LED



◀ 82291517

šedá/bílá, kov/textil/plast

↑120 Ø760

60 W/3000–5000 K/5800 lm, 230 V, IP20, LED



A++ A LED

▶ 82396679

šedohnědá/bílá, kov/textil/plast

↑105 Ø980

80 W/3000–5000 K/7800 lm, 230 V, IP20, LED



A++ A LED



▶ **82396149**

černá, kov
 ↑3000 Ø224 (jedno stínítko)
 3× 15 W, 230 V, IP20, E27



A++ E

▼ **82396150**

černá/měď, kov
 ↑2000 Ø105
 10 W, 230 V, IP20, GU10

A++ E



▲ **82395945**

stříbrná, kov/textil/plast
 ↑100 Ø500
 40 W/3000 K/3400 lm, 230 V, IP20, LED



A++ A **LED**

▲ **82396689**

smetanová, kov/textil/plast
 ↑100 Ø400
 30 W/3000 K/2550 lm, 230 V, IP20, LED



A++ A **LED**

◀ **82396688**

zlatá, kov/textil/plast
 ↑90 Ø250
 18 W/3000 K/1170 lm, 230 V, IP20, LED



A++ A **LED**



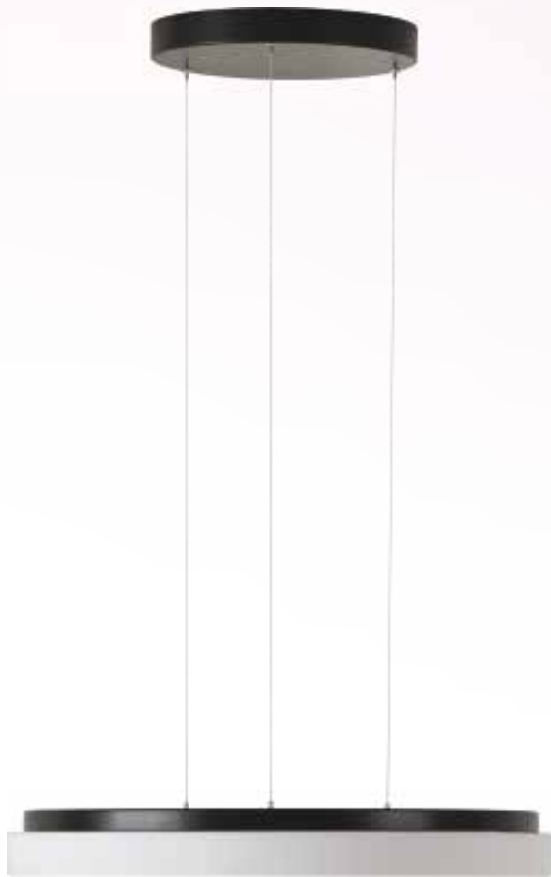

▼ **81783789**

bílá, plast/kov
 ↑130 Ø600
 36 W/4000 K/2100 lm, 230 V, IP20, LED



A+ LED



▲ **82382292**

černá/bílá, kov/sklo
 ↑1055 Ø500
 50 W/3000 K/4250 lm, 230 V, IP 41, LED

A++ A LED



▲ **81689636**

bílá, sklo/kov
 ↑140 Ø500
 3x 60 W, 230 V, IP20, E27

A++ E

► **81748508**

bílá, sklo/kov
 ↑1060 Ø425
 3x 60 W, 230 V, IP20, E27

A++ E



◀ **81783790**

bílá, plast/kov
 ↑1500 Ø600
 36 W/4000 K/2100 lm, 230 V, IP20, LED



A+ LED



◀ **81783746**

černá, sklo/kov
 ↑1100 Ø105
 40 W, 230 V, IP20, E14



A++ E



◀ **81761392**

bílá, sklo/kov
 ↑1100 Ø105
 40 W, 230 V, IP20, E14



A++ E



▶ **81783747**

červená, sklo/kov
 ↑1115 Ø145
 60 W, 230 V, IP20, E27



A++ E

▶ **81783758**

červená, sklo/kov
 ↑1100 Ø105
 40 W, 230 V, IP20, E14

A++ E



◀ **81689626**

bílá, sklo/kov
 ↑1115 Ø145
 60 W, 230 V, IP20, E27



A++ E



◀ **81757212**

černá, sklo/kov
 ↑1115 Ø145
 60 W, 230 V, IP20, E27

A++ E



▲ 80991212

bílá/matný nikel, kov/sklo
 ↑1100 Ø350
 2x 60 W, 230 V, IP20, E27



A++ E



▶ 80991214

bílá/matný nikel, kov/sklo
 ↑1570 Ø350
 2x 60 W, 230 V, IP20, E27



A++ E

▲ 80991213

bílá/matný nikel, kov/sklo
 ↑1100 Ø445
 2x 60 W, 230 V, IP20, E27



A++ E



◀ 80991211

bílá/matný nikel, kov/sklo
 ↑210 Ø350
 2x 60 W, 230 V, IP20, E27



A++ E

▲ 60993248

bílá/matný nikel, kov/sklo
 ↑160 Ø280
 2x 60 W, 230 V, IP20, E27



A++ E



▶ **82294980**

champagne/zlatá, kov/textil

↑110 Ø380

60 W, 230 V, IP20, E27



◀ **82199034**

champagne/zlatá, kov/textil

↑1100 Ø530

3× 60 W, 230 V, IP20, E27

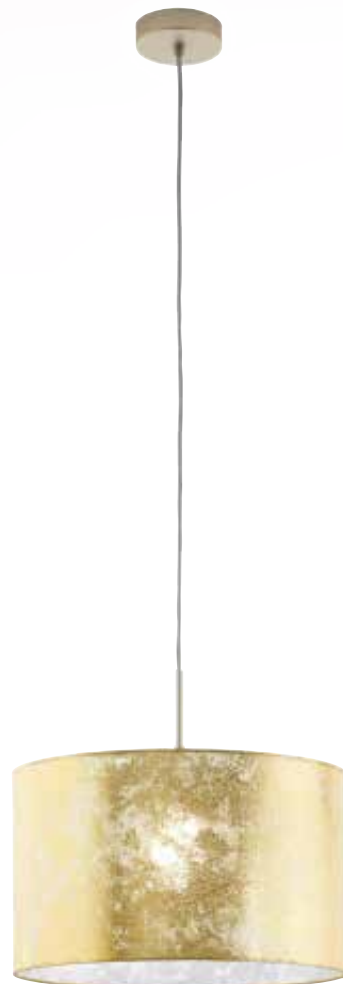

◀ **82396680**

champagne/zlatá, kov/textil

↑305 →145

60 W, 230 V, IP20, E27



▲ **82294976**

champagne/zlatá, kov/textil

↑195 Ø470

3× 60 W, 230 V, IP20, E27



▲ **82287375**

champagne/zlatá, kov/textil

↑1100 Ø380

60 W, 230 V, IP20, E27



◀ **82199999**

champagne/zlatá, kov/textil

↑1585 Ø280

60 W, 230 V, IP20, E27



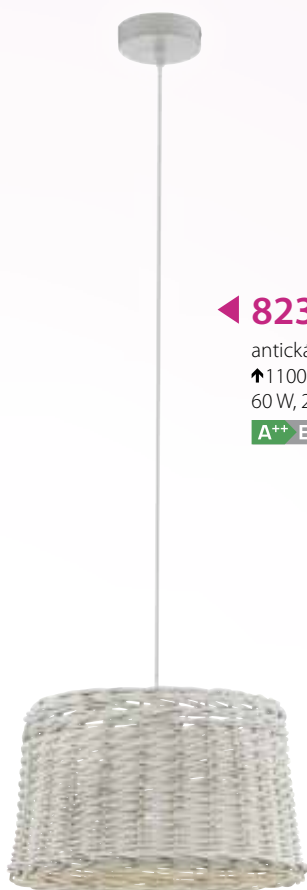

◀ **82396682**

antická bílá, kov/dřevo
 ↑1100 Ø360
 60 W, 230 V, IP20, E27

A++ E

▶ **82396690**

přírodní, kov/ratan
 ↑1200 Ø340
 40 W, 230 V, IP20, E27

A++ E



▶ **82396681**

bílá/hnědá, kov/dřevo
 ↑1100 Ø510
 60 W, 230 V, IP20, E27

A++ E

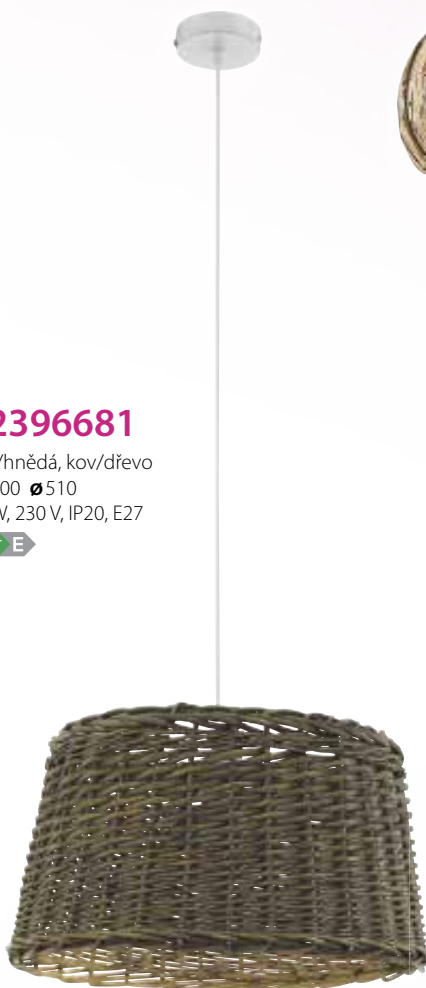

◀ **82396683**

hnědá, kov/dřevo
 ↑1100 Ø310
 60 W, 230 V, IP20, E27

A++ E



▶ **82396684**

antická bílá, kov/dřevo
 ↑1100 Ø370
 60 W, 230 V, IP20, E27

A++ E

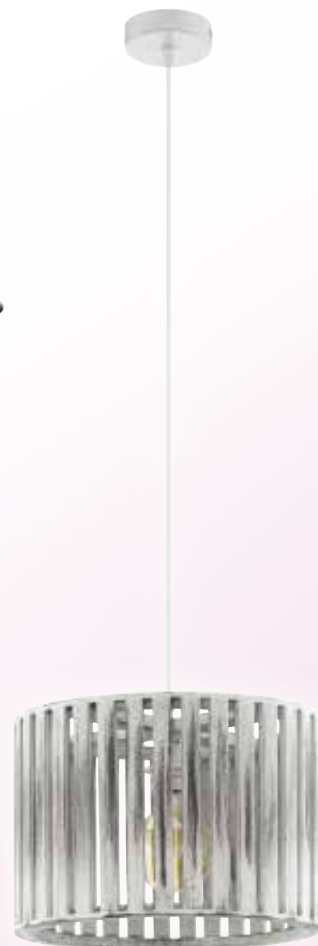



◀ 82396698

průhledná/bílá, kov/plast
 ↑2000 Ø536
 21 W/3000 K/2268 lm, 230 V, IP20, LED



A+ LED

▶ 82198257

bílá/chrom, kov/plast
 ↑1100 →790 Ø60
 2× 8,5 W/3000 K/2000 lm, 230 V, IP20, LED

A++ A LED



▲ 82296941

bílá/chrom, kov/plast
 ↑90 →858 Ø80
 2× 10 W/3000 K/2600 lm, 230 V, IP20, LED

A++ A LED



▲ 82396048

průhledná/bílá, kov/plast
 ↑2000 Ø833
 42 W/3000 K/4370 lm, 230 V, IP20, LED



A+ LED

▶ 81690308

čirá/chrom, plast/kov
 ↑1100 →780 ↗90
 4× 4,5 W/3000 K/1920 lm, 230 V, IP20, LED

A++ A LED



▶ **82396686**

čirá/chrom, kov/křišťál
 ↑125 Ø500
 15x 2,5 W/3000 K/4050 lm, 230 V, IP20, LED

A+ LED

◀ **82396687**

zlatá, kov/křišťál
 ↑1490 Ø680
 21x 1,2 W/2700 K/2100 lm, 230 V, IP20, G4

A++



◀ **81586513**

průhledná, sklo/křišťál/kov
 ↑230 Ø400
 3x 40 W, 230 V, IP20, E14



A++ E



▶ **81295908**

průhledná, sklo/křišťál/kov
 ↑1000 Ø400
 3x 40 W, 230 V, IP20, E14



A++ E



▲ **82396685**

čirá/zlatá, kov/broušené sklo
 ↑125 Ø700
 14x 3,15 W/3000 K/5320 lm, 230 V, IP20, LED

A+ LED

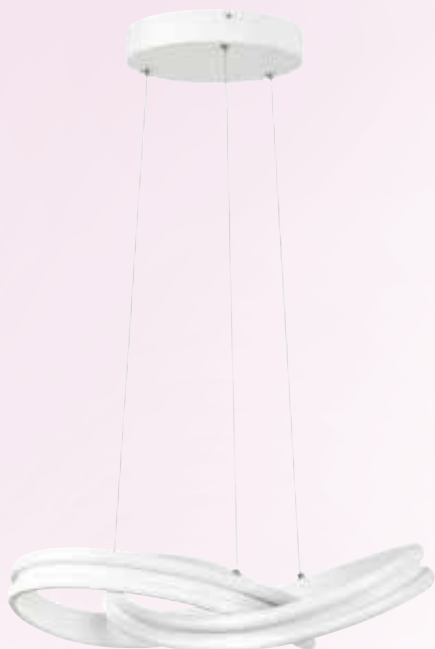

▶ **82396691**

hnědá, kov/plast
 ↑1500 Ø600
 40 W/3000 K/2700 lm, 230 V, IP20, LED
 A+ LED



▲ **82381313**

bílá, kov/plast
 ↑1500 Ø550
 60 W/3000 K/3600 lm, 230 V, IP20, LED

 A+ LED



▶ **81770123**

bílá/šedá, plast/kov
 ↑1500 Ø800
 110 W/3000–3500 K/8800 lm, 230 V, IP20, LED

 A+ LED



◀ **81764842**

bílá/šedá, plast/kov
 ↑1500 Ø800
 100 W/3000 K/6000–7000 lm, 230 V, IP20, LED

 A+ LED

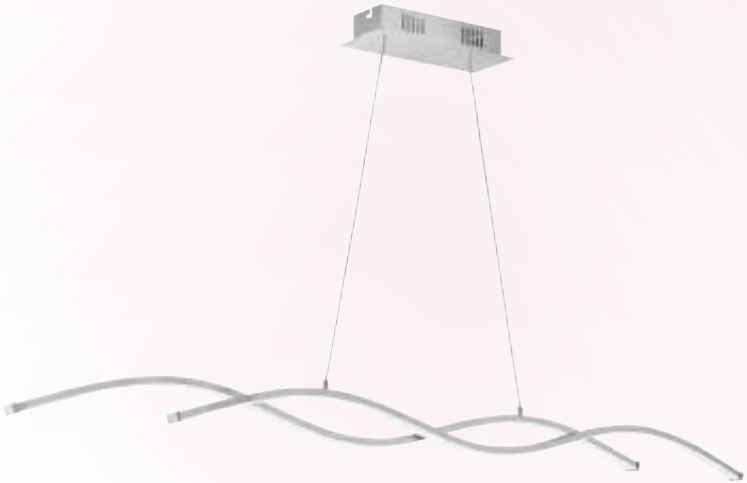

▲ **81770751**

chrom, plast/kov
 ↑1200 →1200 ↗110
 2× 14 W/3000 K/3800 lm, 230 V, IP20, LED



A+ LED

▼ **82199993**

zlatá/bílá, kov/plast
 ↑1200 →865 ↗80
 2× 9 W/3000 K/2400 lm, 230 V, IP20, LED

A++ A LED

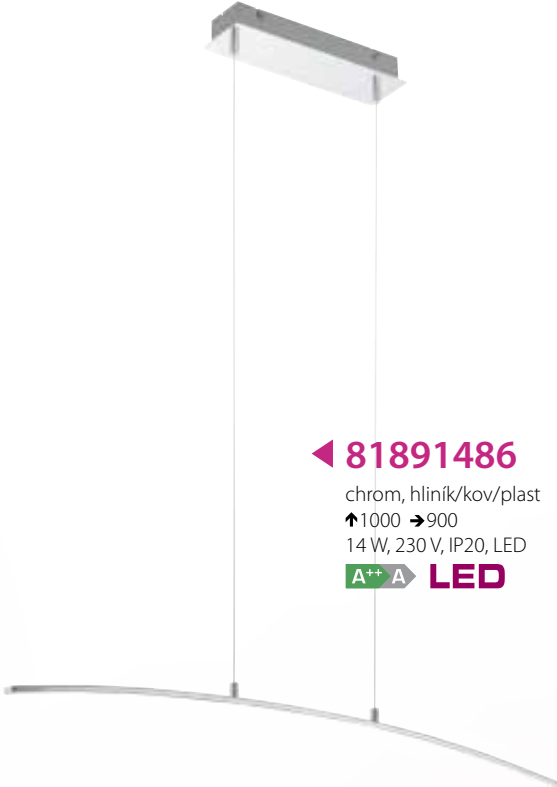

◀ **81891486**

chrom, hliník/kov/plast
 ↑1000 →900
 14 W, 230 V, IP20, LED

A++ A LED

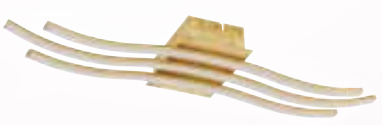

▲ **82199998**

zlatá/bílá, kov/plast
 ↑65 →605 ↗155
 18 W/2× 8,6 W, 1× 8,6 W/3000 K/2000 lm, 230 V, IP20, LED

A++ A LED

▶ **81770734**

chrom/bílá, kov/plast
 ↑95 →500 ↗160
 18 W/3000 K/1890 lm, 230 V, IP20, LED

A++ A LED



▶ **81769167**

chrom, plast/kov
 ↑1500 →1200 ↗80
 19,2 W/3000 K/1550 lm, 230 V, IP20, LED



A+ LED



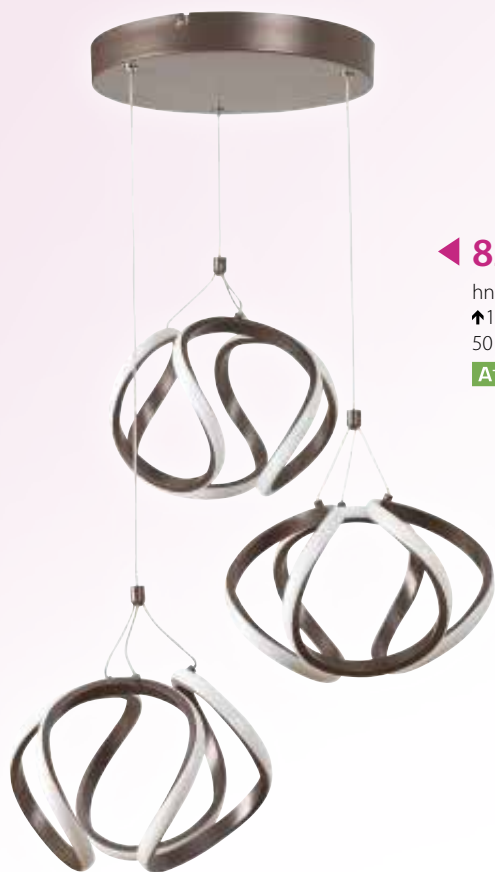

◀ **82393823**

hnědá, kov/plast
 ↑1500 →500
 50 W/3000 K/3400 lm, 230 V, IP20, LED
A+ LED



▶ **82384252**

chrom, kov/plast
 ↑1500 →500
 50 W/3000 K/3400 lm, 230 V, IP20, LED
A+ LED



◀ **82396692**

chrom, kov/plast
 ↑240 Ø 270
 11 W/3000 K/700 lm, 230 V, IP20, LED
A+ LED



▶ **82381314**

chrom, kov/plast
 ↑1500 Ø 560
 38 W/3000 K/2500 lm, 230 V, IP20, LED
A+ LED



▲ **81783840**

antická hnědá, kov
 ↑240 Ø 270
 11 W/3000 K/700 lm, 230 V, IP20, LED
A+ LED

▶ **81587660**

opálová/čirá/chrom, kov/sklo
 ↑1500 Ø500
 5x 60 W, 230 V, IP20, E27



A++ E



◀ **80991229**

opálová/čirá/chrom, kov/sklo
 ↑1100 Ø110
 60 W, 230 V, IP20, E27



A++ E



▲ **80991230**

opálová/čirá/chrom, kov/sklo
 ↑1100 →725
 3x 60 W, 230 V, IP20, E27



A++ E



▼ **82198995**

černá/zlatá, kov/sklo
 ↑550 Ø110
 60 W, 230 V, IP20, E27

A++ E



◀ **82287379**

černá/zlatá, kov/sklo
 ↑1470 Ø110
 60 W, 230 V, IP20, E27

A++ E

▲ **80991231**

opálová/čirá/chrom, kov/sklo
 ↑1100 →905
 4x 60 W, 230 V, IP20, E27



A++ E



◀ 81889554

bílá, kov/plast
 ↑2000 Ø 520
 23 W/3000 K/2794 lm, 230 V, IP20, LED



A LED



▲ 81890714

bílá, kov/plast
 ↑136 Ø 760
 32 W/3000 K/3929 lm, 230 V, IP20, LED



A LED



◀ 81690316

černá, sklo/kov
 ↑1100 →990 ↗190
 3× 60 W, 230 V, IP20, E27



A++ E

▶ 81693107

černá, sklo/kov
 ↑1100 Ø 190
 60 W, 230 V, IP20, E27



A++ E



◀ 81690289

bílá, sklo/kov
 ↑1100 Ø 190
 60 W, 230 V, IP20, E27



A++ E

▶ 81686149

bílá, sklo/kov
 ↑1100 →990 ↗190
 3× 60 W, 230 V, IP20, E27



A++ E





◀ **81682156**

čirá/chrom, sklo/kov
 ↑1100 →900
 4× 60 W, 230 V, IP20, E27
 A++ E

▼ **81783760**

čirá/chrom, sklo/kov
 ↑1400 Ø300
 60 W, 230 V, IP20, E27



A++ E



▼ **81783762**

bílá/chrom, sklo/kov
 ↑1400 Ø300
 60 W, 230 V, IP20, E27



A++ E



▲ **81783761**

čirá/chrom, sklo/kov
 ↑1400 Ø300
 60 W, 230 V, IP20, E27

A++ E



▲ 81680132

krémová/bílá, plast/textil
 ↑110 Ø500
 24 W/3000K/2210 lm, 230 V, IP20, LED



A+ LED



▲ 81757515

šedohnědá/bílá, textil/sklo
 ↑195 Ø475
 3x 60W, 230 V, IP20, E27

A++ E

▶ 81698296

antracit/bílá, plast/textil
 ↑90 Ø320
 11 W/3000 K/850 lm, 230 V, IP20, LED

A+ LED



▼ 81881968

bílá, plast/textil
 ↑100 Ø405
 18 W/3000 K/2000 lm, 230 V, IP20, LED



A++ A LED

▲ 81757065

matný nikl, kov/textil/sklo
 ↑195 Ø475
 3x 60 W, 230 V, IP20, E27

A++ E



◀ 81770334

matný nikl, kov/textil/sklo
 ↑195 Ø475
 3x 60 W, 230 V, IP20, E27

A++ E



◀ 82396696

matný nikl/barevná, kov/textil
 ↑1500 →890 ↗160
 4× 40 W, 230 V, IP20, E14

A++ E

▼ 82396697

matný nikl/šedá, kov/textil
 ↑1500 →770 ↗130
 4× 28 W, 230 V, IP20, E14

A++ E



◀ 81756170

matný nikl, kov
 ↑1100 Ø545
 3× 60 W, 230 V, IP20, E27

A++ E

▶ 82199019

černá, kov
 ↑1520 →275 ↗35
 3× 40 W, 230 V, IP20, E14

A++ E



◀ 82199001

bílá, kov/textil
 ↑255 →610 ↗495
 3× 60 W, 230 V, IP20, E27

A++ E



▶ **82396695**

saténový chrom/bílá, kov
 ↑1500 →980
 20 W/3000 K/1150 lm, 230 V, IP20, LED
A+ LED



◀ **82396693**

saténový chrom/bílá, kov
 ↑425 →250 ↗150
 9 W/3000 K/500 lm, 230 V, IP20, LED
A+ LED



▶ **82396694**

saténový chrom/bílá, kov
 ↑440 →160
 9 W/3000 K/500 lm, 230 V, IP20, LED
A+ LED



◀ **82381297**

saténový chrom/bílá, kov
 →530 ↗530
 31 W/3000 K/2000 lm, 230 V, IP20, LED
A+ LED

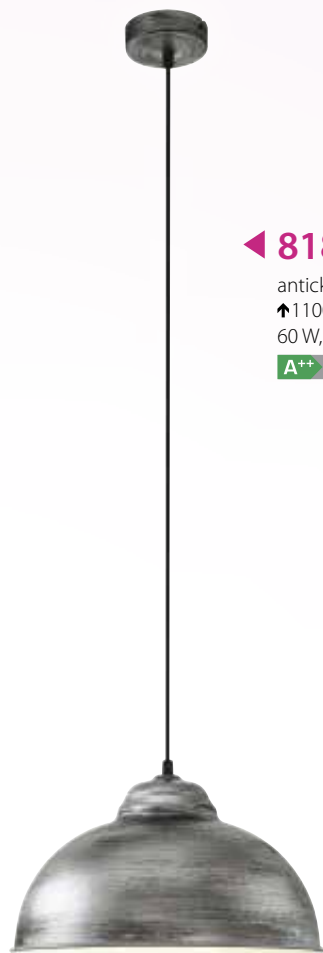

◀ **81879676**

antická/stříbrná, kov
 ↑1100 Ø370
 60 W, 230 V, IP20, E27

A++ E

▶ **81779040**

černá/měď, kov
 ↑1100 Ø370
 60 W, 230 V, IP20, E27

A++ E



▼ **81690279**

antická/měděná, kov
 ↑1100 Ø370
 60 W, 230 V, IP20, E27

A++ E

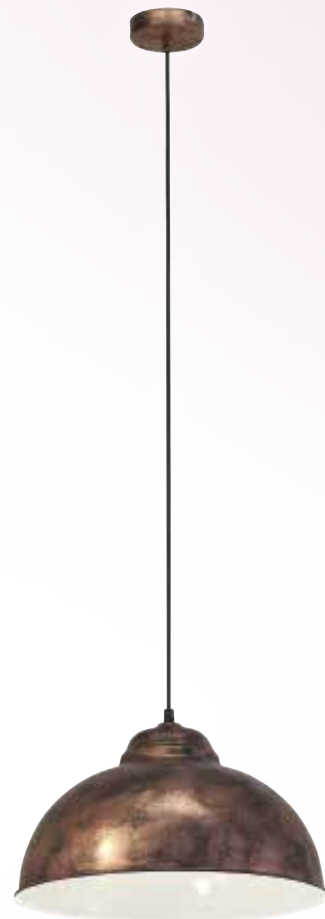

◀ **81690285**

hnědá, kov
 ↑1100 →800 ↗300
 2× 60 W, 230 V, IP20, E27

A++ E



◀ **81690284**

antická/hnědá/běžová, kov
 ↑1100 Ø360
 60 W, 230 V, IP20, E27

A++ E



▲ 81692450

bílá, kov
 ↑1100 Ø400
 60 W, 230 V, IP20, E27



A++ E

▼ 82096808

černá/měď, kov
 ↑1100 →1000
 6x 60 W, 230 V, IP20, E27

A++ E

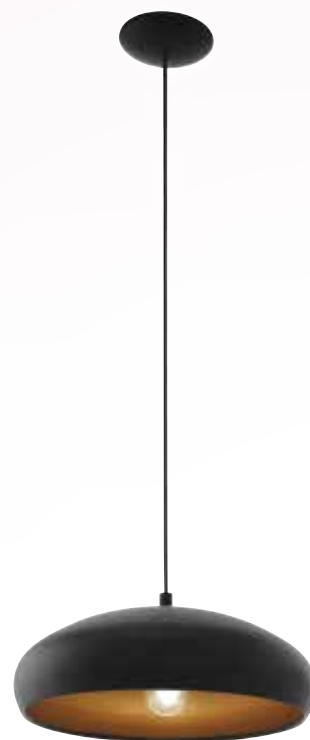

▲ 81754056

černá, kov
 ↑1100 Ø400
 60 W, 230 V, IP20, E27

A++ E



◀ 82299788

bílá, kov
 ↑1100 →700 ↗105
 4x 60 W, 230 V, IP20, E27

A++ E



▶ 82296860

černá/hnědá/rustikal, kov/dřevo
 ↑1100 →1180 ↗260
 3x 60 W, 230 V, IP20, E27

A++ E



▶ **81890602**

matná černá, kov
 ↑600 Ø 500
 5× 15 W, 230 V, IP20, E27

A++ E

▼ **81890601**

matná černá, kov
 ↑700 Ø 340
 3× 15 W, 230 V, IP20, E27

A++ E

▼ **81890599**

matná černá, kov
 ↑190 Ø 350
 3× 15 W, 230 V, IP20, E27

A++ E

▶ **81890600**

matná černá, kov
 ↑200 Ø 570
 5× 15 W, 230 V, IP20, E27

A++ E





◀ **81890597**

hnědá, kov
 ↑1200 Ø310
 60 W, 230 V, IP20, E27



A++ E



▲ **81783814**

zlatá/bronz, kov
 ↑1090 Ø250
 40 W, 230 V, IP20, E27

A++ E



▲ **81783816**

zlatá/bronz, kov
 ↑1060 Ø400
 40 W, 230 V, IP20, E27



A++ E



◀ **81783813**

zlatá/bronz, kov
 ↑1060 Ø320
 40 W, 230 V, IP20, E27



A++ E



◀ **81593476**

bílá, kov/sklo
 ↑1140 Ø490
 3x 60 W, 230 V, IP20, E27

A++ E

◀ **81489699**

bílá/matný nikl, kov/sklo
 ↑1100 Ø300
 60 W, 230 V, IP20, E27

A++ E



▲ **81893787**

bílá/nerez, kov/sklo
 ↑1000 Ø400
 29 W/3000 K/3900 lm, 230 V, IP40, LED
 světelný zdroj je součástí balení

A+ LED



◀ **81267086**

bílá/matný nikl, kov/sklo
 ↑315 Ø250
 60 W, 230 V, IP20, E27

A++ E

▶ **81698215**

bílá/matný nikl, kov/sklo
 ↑1100 Ø250
 60 W, 230 V, IP20, E27

A++ E







▲ 81891197

bílá, plast
 Ø800
 100 W/2700–6500 K/6600 lm, 230 V, IP20, LED



A → LED

▲ 81891196

bílá/noční obloha, plast
 Ø800
 100 W/2700–6500 K/6600 lm, 230 V, IP20, LED



A → LED



◀ 82381292

bílá/noční obloha, kov/plast
 Ø380
 48 W/3000–6500 K/2880 lm, 230 V, IP20, LED



A+ → LED

▲ 82384247

bílá/noční obloha, kov/plast
 Ø480
 72 W/3000–6500 K/4320 lm, 230 V, IP20, LED



A+ → LED



▲ 82384246

bílá/noční obloha, kov/plast
 ↑80 Ø600
 42 W/3000–6500 K/3400 lm, 230 V, IP20, LED, RGB



A → LED

▲ 81770742

bílá/noční obloha, plast
 Ø580
 30 W/3000–6500 K/3500 lm, 230 V, IP20, LED



A+ → LED



◀ 82382082

bílá/noční obloha, kov/plast
 ↑75 Ø400
 32 W/3000–6500 K/2400 lm, 230 V, IP20, LED, RGB



A → LED



◀ 81752760

bílá/hliník, plast/kov
 ↑65 →525 ↗525
 50 W/3000–5500 K/4000 lm, 230 V, IP20, LED



▶ 81683789

bílá/hliník, plast/kov
 ↑65 Ø 600
 45 W/3000–5500 K/4000 lm, 230 V, IP20, LED



▼ 81779462

bílá/noční obloha, plast
 ↑60 →425 ↗425
 30 W, 3000–5500 K/2400 lm, 230 V, IP20, LED



▲ 81779461

bílá/noční obloha, plast
 ↑60 Ø 420
 30 W/3000–5500 K/2400 lm, 230 V, IP20, LED



◀ 81797392

bílá/noční obloha, plast
 ↑108 Ø 566
 38 W/2800–6000 K/3600 lm, 230 V, IP20, LED





◀ **81772671**

bílá/noční obloha, plast
 Ø 500
 50 W/3000–6000 K/4100 lm, 230 V, IP20, LED



A+ LED

▶ **81763258**

bílá/noční obloha, plast
 Ø 380
 24 W/4000 K/1600 lm, 230 V, IP20, LED



A+ LED



◀ **81765845**

bílá/noční obloha, plast
 ↑420 →420 ↗50
 36 W/4000 K/3000 lm, 230 V, IP20, LED



A+ LED

▶ **81772972**

bílá/noční obloha, plast
 ↑520 →520 ↗50
 48 W/4000 K/3800 lm, 230 V, IP20, LED



A+ LED





▲ 81891198

bílá/chrom, sklo/kov
 ↑300 →300 ↗75
 12 W/4000 K/960 lm, 230 V, IP20, LED



A+ LED

▼ 81891199

bílá/chrom, sklo/kov
 ↑380 →380 ↗75
 24 W/4000 K/1970 lm, 230 V, IP20, LED



A+ LED



◀ 81891200

bílá/chrom, sklo/kov
 ↑480 →480 ↗75
 36 W/4000 K/2700 lm, 230 V, IP20, LED



A+ LED

▼ 81789535

bílá/noční obloha, kov/plast
 ↑90 →375 ↗375
 20 W/2700–6500 K/2200 lm, 230 V, IP20, LED



A+ LED



▲ 81775423

bílá/noční obloha, kov/plast
 ↑105 ∅380
 20 W/2700–6500 K/2500 lm, 230 V, IP20, LED



A+ LED

▼ 81758229

bílá, kov/plast
 ↑800 →800 ↗110
 110 W/3000 K/6500 lm, 230 V, IP20, LED



A+ LED

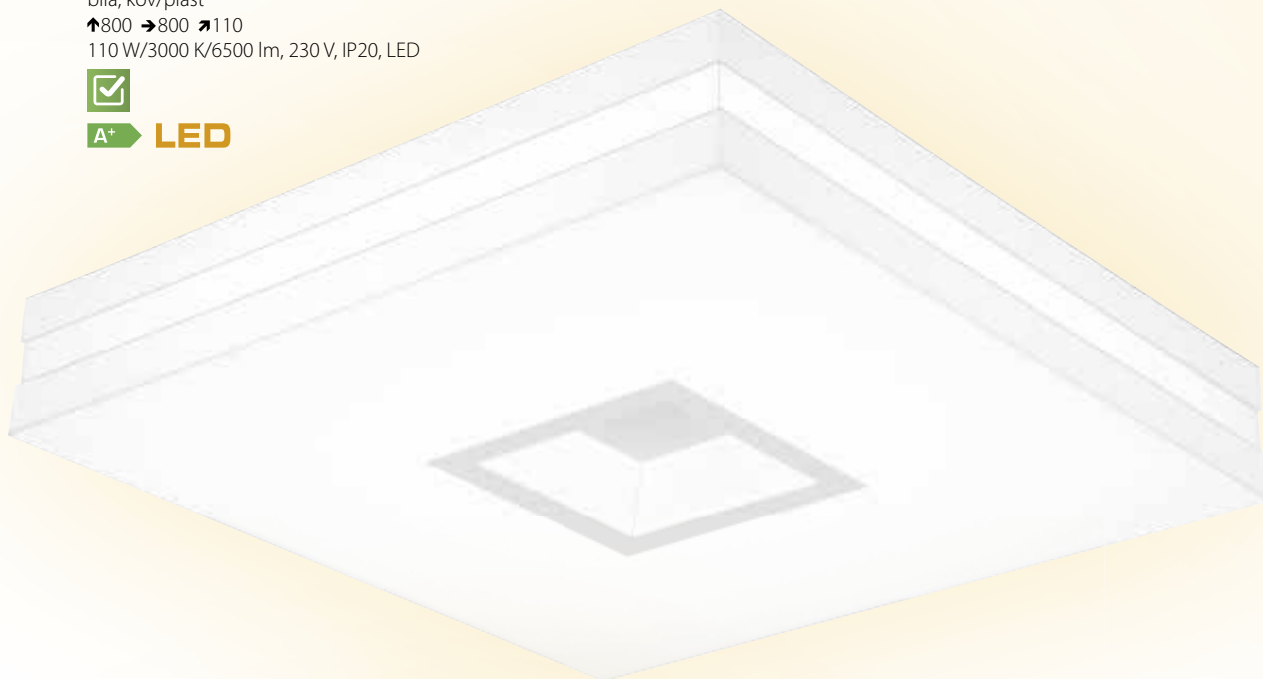

◀ 81781745

bílá, kov/plast
 ↑500 →500 ↗110
 42 W/3000 K/2730 lm, 230 V, IP20, LED



A+ LED



▼ 81779607

bílá, kov/plast
 ↑75 Ø400
 26 W/3000 K/1690 lm, 230 V, IP20, LED



A+ LED



▲ 81758234

bílá, kov/plast
 ↑402 →402 ↗75
 30 W/3000 K/1950 lm, 230 V, IP20, LED



A+ LED



▼ **81782808**

bílá, kov/plast
 ↑100 Ø600
 50 W/3000 K/5100 lm, 230 V, IP20, LED



A+ LED

▲ **81758057**

bílá, kov/plast
 ↑100 Ø500
 35 W/3000 K/3400 lm, 230 V, IP20, LED



A+ LED



▼ **81888622**

matná černá, kov/plast
 ↑100 Ø400
 25 W/3000 K/2250 lm, 230 V, IP20, LED



A++ A LED

▲ **81781746**

bílá, kov/plast
 ↑100 Ø570
 51 W/3000 K/3315 lm, 230 V, IP20, LED

A+ LED



◀ **81891211**

matná černá, kov/plast
 ↑110 Ø455
 32 W/3000 K/2080 lm, 230 V, IP20, LED



A++ A LED



◀ **82398878**

leštěný hliník, plast/kov
 ↑410 →410
 24 W/3000 K/1440 lm, 230 V, IP20, LED



A → **LED**

▶ **82384248**

leštěný hliník, plast/kov
 ↑300 →300
 18 W/3000 K/1080 lm, 230 V, IP20, LED



A → **LED**



▼ **81756691**

bílá, plast
 Ø350
 21 W/3000 K/1365 lm, 230 V, IP20, LED

A+ → **LED**

▲ **81891201**

chrom/krystal, metal akryl/plast
 Ø400
 22 W/2700–6500 K/1850 lm, 230 V, IP20, LED



A+ → **LED**



◀ **81758238**

bílá, plast
 Ø480
 35 W/3000 K/2275 lm, 230 V, IP20, LED

A+ → **LED**



▼ **81297695**

bílá/chrom, sklo/kov
 ↑72 →300 ↗300
 2x 60 W, 230 V, IP20, E27



A++ E



▲ **81189792**

bílá/chrom, sklo/kov
 ↑72 →380 ↗380
 3x 60 W, 230 V, IP20, E27



A++ E



▲ **81399225**

hliník, sklo/kov
 ↑80 →400 ↗400
 4x 40 W, 230 V, IP20, E27



A++ E

▼ **81281497**

bílá, sklo/kov
 ↑67 →300 ↗300
 2x 60 W, 230 V, IP20, E27



A++ E



▲ **81399226**

hliník, sklo/kov
 ↑80 →300 ↗300
 3x 60 W, 230 V, IP20, E27



A++ E





◀ 81398997

chrom, sklo/kov
 ↑290 →290 ↗70
 4x 3 W/3000 K/960 lm, 230 V, IP20, GU10, LED

A+ LED



▼ 82199005

bílá/noční obloha, kov/plast
 ↑100 Ø660
 40 W/3000–5000 K/4000 lm, 230 V, IP20, LED



A+ LED

▲ 82199966

bílá/noční obloha, kov/plast
 ↑70 →430 ↗430
 33,5 W/3000 K/3400 lm, 230 V, IP20, LED



A+ LED



▶ 82094248

bílá, kov/plast
 ↑75 Ø570
 40 W/3000–5000 K/4000 lm, 230 V, IP20, LED



A+ LED



◀ 82199936

bílá/noční obloha, kov/plast
 ↑75 Ø570
 40 W/3000–5000 K/4000 lm, 230 V, IP20, LED



A+ LED





◀ 82398894

černá, kov
 ↑200 →150 ↗150
 60 W, 230 V, IP20, E27
 A++ E

▼ 82398891

černá, kov
 ↑415 →760
 5 × 60 W, 230 V, IP20, E27
 A++ E



▼ 81891210

černá/zlatá, kov/sklo
 ↑430 →930
 60 W, 230 V, IP20, E27
 A++ E



▲ 81756460

bílá, kov
 ↑240 →290-750
 60 W, 230 V, IP20, E27
 A++ E

▶ 81891209

černá, kov
 ↑245 →290-750
 60 W, 230 V, IP20, E27
 A++ E





▲ 81891292

šedá, kov/plast
 ↑75 Ø 360
 21 W/4000 K/2500 lm, 230 V, IP20, LED
A++ A LED

▶ 81891293

bílá, kov/plast
 ↑75 Ø 260
 13 W/4000 K/1500 lm, 230 V, IP20, LED
A++ A LED



◀ 81891294

černá, kov/plast
 ↑75 Ø 360
 21 W/3000 K/2500 lm, 230 V, IP20, LED
A++ A LED



◀ 81891295

hnědá, kov/plast
 ↑75 Ø 260
 13 W/3000 K/1500 lm, 230 V, IP20, LED
A++ A LED



◀ 82398909

bílá, dřevo/sklo
 ↑80 →405 ↗115
 60 W, 230 V, IP20, E27
 A++ E

▶ 82398911

wenge, dřevo/sklo
 ↑80 →405 ↗115
 60 W, 230 V, IP20, E27
 A++ E



◀ 82398923

rustikální, dřevo/sklo
 ↑80 →405 ↗115
 60 W, 230 V, IP20, E27
 A++ E

▼ 81890956

bílá, dřevo/sklo
 ↑80 Ø 250
 60 W, 230 V, IP20, E27
 A++ E



◀ 81890955

rustikální, dřevo/sklo
 ↑80 Ø 350
 60 W, 230 V, IP20, E27
 A++ E



▶ 82398927

wenge, dřevo/sklo
 ↑80 Ø 450
 60 W, 230 V, IP20, E27
 A++ E





▲ 81492001

bílá/chrom, sklo/kov
 Ø 300
 60 W, 230 V, IP20, E27



A++ E

◀ 81492015

bílá/chrom, sklo/kov
 Ø 400
 2× 60 W, 230 V, IP20, E27



A++ E

▶ 82398928

černá/zlatá, kov/plast
 ↑90 Ø 495
 24,5 W/2700–6500 K/3000 lm, 230 V, IP20, LED



A++ A LED



◀ 81799584

bílá, kov/plast
 ↑100 Ø 455
 25,5 W/3000 K/3000 lm, 230 V, IP20, LED

A++ A LED



◀ **81493940**

bílá/chrom, sklo/kov
 ↑400 →400 ↗65
 2× 60 W, 230 V, IP20, E27



A++ E

▶ **81698673**

bílá, sklo/kov
 ↑400 →400
 2× 60 W, 230 V, IP20, E27

A++ E



◀ **81596794**

bílá, sklo/kov
 ↑300 →300
 60 W, 230 V, IP20, E27

A++ E

▶ **81770740**

bílá, kov/plast
 ↑60 Ø 410
 22 W/3000–6000 K/2500 lm, 230 V, IP20, E27, LED



A+ LED



▶ **82386539**

bílá, kov/plast
 ↑140 →460 ↻60
 8 W/4000 K/450 lm, 230 V, IP23, LED



A+ LED

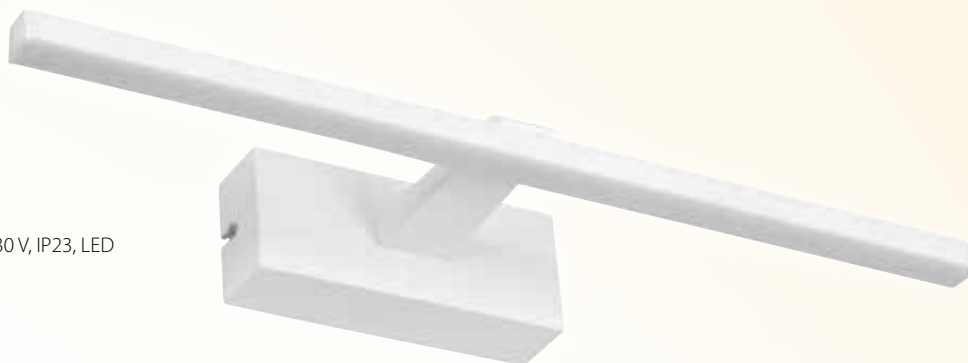

▼ **82393844**

bílá, kov/plast
 ↑140 →600 ↻60
 12 W/4000 K/795 lm, 230 V, IP23, LED



A+ LED

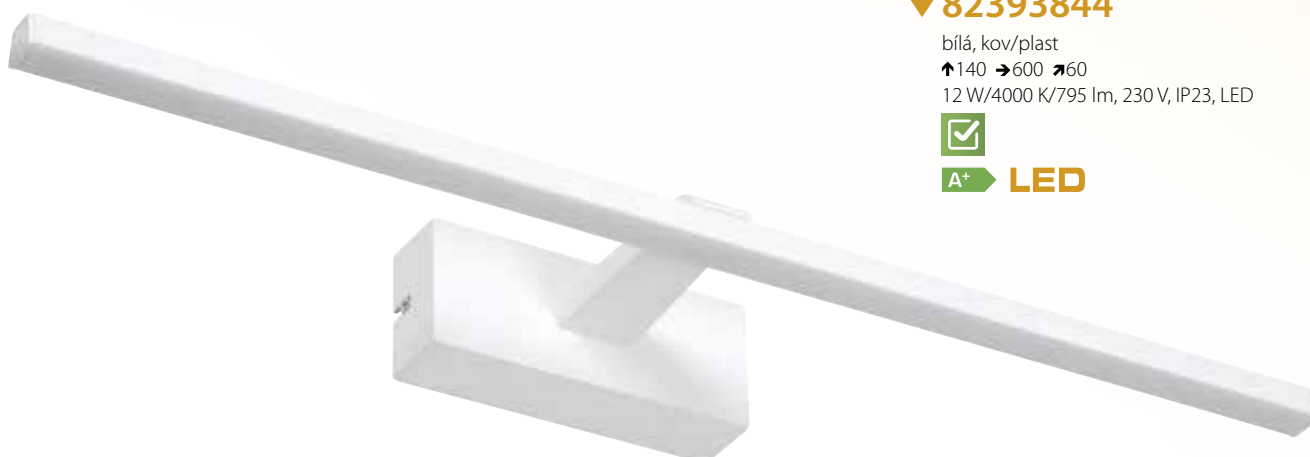

▲ **81686467**

chrom, kov
 ↑165 →455 ↻55
 8 W/3000 K/580 lm, 230 V, IP20, LED



A+ LED



▼ **81595950**

chrom, kov/plast
 ↑45 →570
 10,5 W/3000 K/830 lm, 230 V, IP20, LED



A+ LED





▼ **81691761**

chrom, kov
 ↑45 →570 ↗190
 12 W/4000 K/466 lm, 230 V, IP20, LED



A+ LED

▶ **82398881**

bílá/chrom, kov/plast
 ↑150 →400 ↗120
 9 W/4000 K/810 lm, 230 V, IP20, LED

A+ LED



◀ **82398882**

bronz, kov/plast
 ↑150 →400 ↗120
 9 W/4000 K/810 lm, 230 V, IP20, LED

A+ LED

▼ **82398886**

bílá/chrom, kov/plast
 ↑150 →550 ↗120
 13 W/4000 K/1170 lm, 230 V, IP20, LED



A+ LED



▲ **82393839**

bronz, kov/plast
 ↑150 →550 ↗120
 13 W/4000 K/1170 lm, 230 V, IP20, LED



A+ LED



◀ **81783204**

bílá/chrom, textil/kov
 ↑550 →160 ↗205
 40 W + 3 W/2800 K/205 lm, 230 V, IP20, E27 + LED



A++ E LED



▶ **81783203**

bílá/chrom, textil/kov
 ↑500 →160 ↗205
 40 W + 3 W/2800 K/205 lm, 230 V, IP20, E27 + LED

A++ E LED



▲ **81783836**

bílá/matný chrom, textil/kov
 ↑360 →180
 40 W + 3 W/2800 K/180 lm, 230 V, IP20, E27 + LED



A++ E LED



◀ **81783834**

broušený hliník, kov
 ↑180 →90
 2x 3 W/2800 K/180 lm + 185 lm, 230 V, IP20, 2x LED

A+ LED



◀ 81891208

šedá, kov/textil
 ↑500 →640 Ø300
 60 W, 230 V, IP20, E27
 A++ E

▼ 81891207

bílá, kov/textil
 ↑500 →640 Ø300
 60 W, 230 V, IP20, E27
 A++ E



◀ 81891718

bílá, kov
 ↑128 Ø57
 50 W, 230 V, IP20, GU10
 A++ E



◀ 81888621

bílá, kov
 ↑90 →26 + 115
 5 W/3000 K/430 lm, 230 V, IP20, LED



A+ LED



▲ 82199731

matný nikl/černá, kov/plast
 ↑300 →65 ↗160
 3,5 W/3000 K/380 lm, 230 V, IP20, LED



A++ A LED

▶ 82295024

černá, kov
 ↑210 →300 ↗130
 10 W, 230 V, IP20, E27



A++ B





◀ **82397404**

bílá, hliník
 ↑80 →200 ↗90
 10 W/3000 K/1100 lm, 230 V, IP20, LED



A++ A **LED**



▲ **82394304**

bílá, hliník
 ↑80 →365 ↗90
 12 W/3000 K/1400 lm, 230 V, IP20, LED



A++ A **LED**



▲ **82394306**

bílá, hliník
 ↑80 →130 ↗90
 6 W/3000 K/600 lm, 230 V, IP20, LED



A++ A **LED**

▶ **82394305**

matný nikl, hliník
 ↑80 →200 ↗90
 10 W/3000 K/1100 lm, 230 V, IP20, LED



A++ A **LED**



▲ **82398929**

matný nikl, hliník
 ↑80 →130 ↗90
 6 W/3000 K/600 lm, 230 V, IP20, LED



A++ A **LED**



▲ **82398930**

matný nikl, hliník
 ↑80 →365 ↗90
 12 W/3000 K/1400 lm, 230 V, IP20, LED



A++ A **LED**



▼ **82295875**

bílá, kov/plast
 ↑130 →130 ↗50
 4,5 W/3000 K/480 lm, 230 V, IP20, LED
A++ A LED



▲ **81880302**

bílá, kov/plast
 ↑200 →170 ↗55
 2× 4,5 W/3000 K/960 lm, 230 V, IP20, LED
A++ A LED

► **81798716**

bílá, kov/plast
 ↑105 →200 ↗60
 5,6 W/3000 K/680 lm, 230 V, IP20, LED
A++ A LED



◀ **81794248**

matný nikl, kov/plast
 ↑105 →200 ↗60
 5,6 W/3000 K/680 lm, 230 V, IP20, LED
A++ A LED



▲ 81753129

bílá, kov
 ↑64 →254 ↗78
 6 W/2700 K/211 lm, 230 V, IP20, LED



A+ LED

▶ 81759756

bílá, kov
 ↑80 →80 ↗120
 6 W/2700 K/272 lm, 230 V, IP20, LED



A+ LED

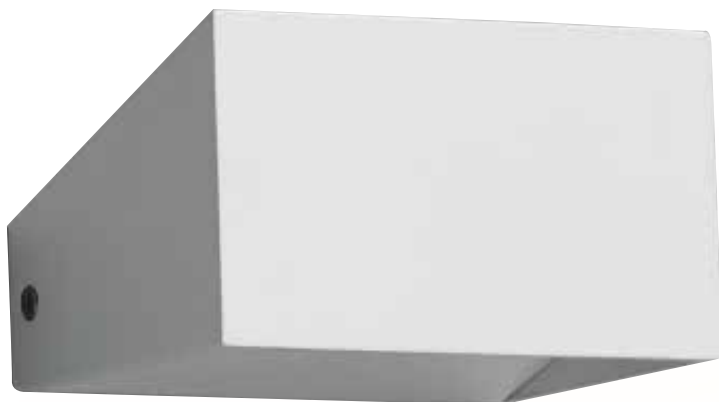

◀ 81761575

bílá, kov
 ↑100 →138 ↗80
 6 W/2700 K/314 lm, 230 V, IP20, LED



A+ LED

▶ 81759125

bílá, kov
 ↑67 →188 ↗104
 6 W/2700 K/355 lm, 230 V, IP20, LED



A+ LED

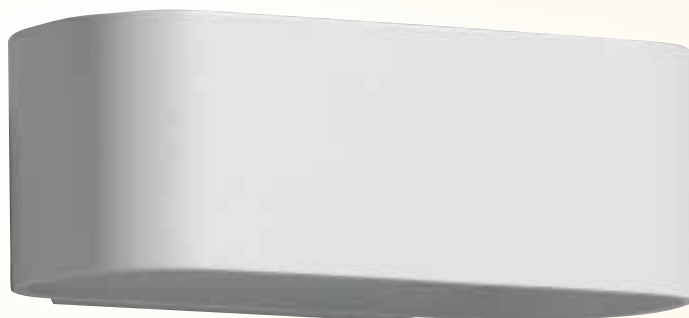

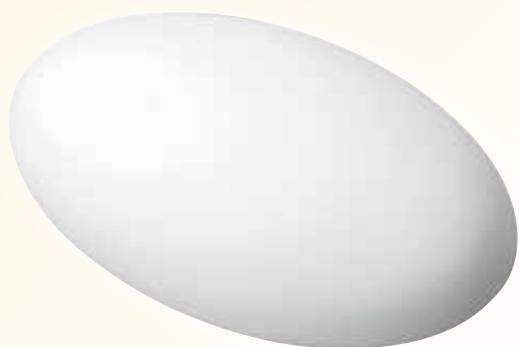

◀ **7379455**

bílá, opálové sklo/kov
 ↑205 →350 ↗140
 2x 60 W, 230 V, IP41, E27



◀ **650043**

bílá, opálové sklo/kov
 ↑205 →350 ↗140
 100 W, 230 V, IP41, E27



▼ **650042**

bílá, opálové sklo/kov
 ↑150 →250 ↗100
 60 W, 230 V, IP41, E27



◀ **650041**

bílá, opálové sklo/kov
 ↑190 →350 ↗150
 100 W, 230 V, IP43, E27



▶ **82398936**

bílá, opálové sklo/plast
 ↑400 Ø 400
 29 W/3000 K/3430 lm, 230 V, IP65, LED



▼ **82398932**

bílá, opálové sklo/plast
 ↑200 Ø 200
 9 W/3000 K/950 lm, 230 V, IP65, LED



◀ **82398935**

bílá, opálové sklo/plast
 ↑300 Ø 300
 22 W/4000 K/2760 lm, 230 V, IP65, LED



◀ **82390061**

bílá, opálové sklo/plast
 ↑300 Ø 300
 22 W/3000 K/2610 lm, 230 V, IP65, LED



▶ **81893799**

bílá, opálové sklo/kov
 ↗90 Ø 420
 21 W/3000 K/2770 lm, 230 V, IP44, LED
 A++ LED

▶ **81765192**

bílá, opálové sklo/kov
 ↗90 Ø 420
 29 W/3000 K/3880 lm, 230 V, IP44, LED
 ✓
 A++ LED

◀ **81893789**

bílá, opálové sklo/kov
 ↗86 Ø 300
 15 W/3000 K/1950 lm, 230 V, IP44, LED
 ✓
 A++ LED

▶ **81769582**

bílá, opálové sklo/kov
 ↗92 Ø 500
 36 W/3000 K/4850 lm, 230 V, IP44, LED
 ✓
 A++ LED

◀ **81893798**

bílá, opálové sklo/kov
 ↗88 Ø 360
 15 W/3000K/2000 lm, 230 V, IP44, LED
 ✓
 A++ LED

◀ **81767882**

bílá, opálové sklo/kov
 ↗88 Ø 360
 20 W/3000 K/2590 lm, 230 V, IP44, LED
 ✓
 A++ LED



◀ **81893800**

bílá, opálové sklo/kov
 ↗86 Ø 300
 11 W/3000 K/1450 lm, 230 V, IP44, LED



A++ LED

▶ **81760235**

bílá, opálové sklo/kov
 ↗84 Ø 250
 11 W/3000 K/1290 lm, 230 V, IP44, LED



A++ LED



▶ **81893801**

bílá, opálové sklo/kov
 ↗84 Ø 250
 9 W/3000 K/1080 lm, 230 V, IP44, LED



A++ LED



◀ **80983212**

bílá, opálové sklo/kov
 ↗105 Ø 350
 100 W, 230 V, IP43, E27



A++ E

▶ **81891202**

bílá, opálové sklo/kov
 ↗105 Ø 280
 11 W/4000 K/1350 lm, 230 V, IP43, LED



A++ LED



▼ 81684631

bílá, kov/plast
 ↑40 Ø 170
 10,9 W/3000 K/1200 lm, 230 V, IP20, LED
 A+ LED

▼ 81684633

bílá, kov/plast
 ↑40 Ø 170
 12 W/4000 K/1350 lm, 230 V, IP20, LED
 A+ LED

▶ 81684637

bílá, kov/plast
 ↑40 Ø 225
 18 W/4000 K/2080 lm, 230 V, IP20, LED
 A+ LED

▶ 81684636

bílá, kov/plast
 ↑40 Ø 225
 16,5 W/3000 K/1600 lm, 230 V, IP20, LED
 A+ LED



▶ 81695451

bílá, kov/plast
 ↑40 Ø 300
 22 W/3000 K/2200 lm, 230 V, IP20, LED
 A+ LED

Vše skladem



◀ 81684634

bílá, kov/plast
 ↑40 → 170 ↗ 170
 10,9 W/3000 K/1200 lm, 230 V, IP20, LED
 A+ LED



◀ 81684635

bílá, kov/plast
 ↑40 → 170 ↗ 170
 12 W/4000 K/1350 lm, 230 V, IP20, LED
 A+ LED

◀ 81748025

bílá, kov/plast
 ↑40 → 300 ↗ 300
 22 W/3000 K/2600 lm, 230 V, IP20, LED
 A+ LED

▲ 81684639

bílá, kov/plast
 ↑40 → 225 ↗ 225
 16,5 W/3000 K/1700 lm, 230 V, IP20, LED
 A+ LED

▲ 81684640

bílá, kov/plast
 ↑40 → 225 ↗ 225
 18 W/4000 K/2080 lm, 230 V, IP20, LED
 A+ LED

▲ 81699108

bílá, kov/plast
 ↑40 → 300 ↗ 300
 24 W/4000 K/2600 lm, 230 V, IP20, LED
 A+ LED

▶ **81698230**

matný nikl, kov/plast
 ↑40 Ø 225
 16,5 W/3000 K/1600 lm, 230 V, IP20, LED
A+ LED

▶ **81771281**

matný nikl, kov/plast
 ↑40 Ø 225
 18 W/4000 K/2080 lm, 230 V, IP20, LED
A+ LED

▶ **81698229**

matný nikl, kov/plast
 ↑40 Ø 300
 22 W/3000 K/2200 lm, 230 V, IP20, LED
A+ LED

▼ **81771283**

matný nikl, kov/plast
 ↑40 Ø 170
 12 W/4000 K/1350 lm, 230 V, IP20, LED
A+ LED

▼ **81748020**

matný nikl, kov/plast
 ↑40 Ø 170
 10,9 W/3000 K/1200 lm, 230 V, IP20, LED
A+ LED

▲ **81771275**

matný nikl, kov/plast
 ↑40 Ø 300
 24 W/4000 K/2600 lm, 230 V, IP20, LED
A+ LED

Vše skladem

◀ **81771284**

matný nikl, kov/plast
 ↑40 → 170 ↗ 170
 12 W/4000 K/1350 lm, 230 V, IP20, LED
A+ LED

◀ **81748021**

matný nikl, kov/plast
 ↑40 → 170 ↗ 170
 10,9 W/3000 K/1200 lm, 230 V, IP20, LED
A+ LED

◀ **81771282**

matný nikl, kov/plast
 ↑40 → 225 ↗ 225
 18 W/4000 K/2080 lm, 230 V, IP20, LED
A+ LED

▲ **81698676**

matný nikl, kov/plast
 ↑40 → 300 ↗ 300
 22 W/3000 K/2600 lm, 230 V, IP20, LED
A+ LED

▲ **81771276**

matný nikl, kov/plast
 ↑40 → 300 ↗ 300
 24 W/4000 K/2600 lm, 230 V, IP20, LED
A+ LED

▲ **81748023**

matný nikl, kov/plast
 ↑40 → 225 ↗ 225
 16,5 W/3000 K/1700 lm, 230 V, IP20, LED
A+ LED

▼ **82287021**

bílá, kov/plast
 ↑30 →400 ↗400
 25 W/4000 K/2500 lm, 230 V, IP20, LED
A++ A LED



▲ **82199025**

bílá, kov/plast
 ↑30 →500 ↗500
 25 W/4000 K/2900 lm, 230 V, IP20, LED

A+ LED



▶ **82292587**

stříbrná, kov/plast
 ↑30 →400 ↗400
 25 W/4000 K/2500 lm, 230 V, IP20, LED
A++ A LED



▶ **82287392**

stříbrná, kov/plast
 ↑30 →500 ↗500
 25 W/4000 K/2900 lm, 230 V, IP20, LED
A+ LED



▶ **82387473**

stříbrná, kov/plast
 ↑30 Ø400
 25 W/4000 K/2500 lm, 230 V, IP20, LED
A++ A LED



▼ **82197307**

stříbrná, kov/plast
 ↑30 Ø500
 25 W/4000 K/2900 lm, 230 V, IP20, LED
A+ LED



▲ **82394836**

bílá, kov/plast
 ↑30 Ø500
 25 W/4000 K/2900 lm, 230 V, IP20, LED
A+ LED



◀ **82287395**

bílá, kov/plast
 ↑30 Ø400
 25 W/4000 K/2500 lm, 230 V, IP20, LED
A++ A LED



▶ **82383909**

bílá, kov/dřevo
 ↑35 ø 180
 8 W/3000 K/640 lm, 230 V, IP20, LED
A+ LED



▼ **82393813**

buk, kov/dřevo
 ↑35 ø 180
 8 W/3000 K/640 lm, 230 V, IP20, LED
A+ LED



◀ **82393814**

černá, kov/dřevo
 ↑35 ø 180
 8 W/3000 K/640 lm, 230 V, IP20, LED
A+ LED

Vše skladem



▶ **82393815**

zlatá, kov/dřevo
 ↑35 ø 180
 8 W/3000 K/640 lm, 230 V, IP20, LED
A+ LED



▲ **82383486**

dub, kov/dřevo
 ↑35 ø 180
 8 W/3000 K/640 lm, 230 V, IP20, LED
A+ LED



◀ **82383487**

beton, kov/dřevo
 ↑35 ø 180
 8 W/3000 K/640 lm, 230 V, IP20, LED
A+ LED

▼ **82293609**

černá/hnědá, ocel/dřevo

↑215 →65 ↗190

10 W, 230 V, IP20, E27

A++ B





▲ **81891782**

nikl-antika/krémová, kov

Ø 100

3,3 W, 230 V, IP20, GU10

A++ B





◀ **81690271**
 černý nikel/chrom, kov
 →365
 2x 3 W, 230 V, IP20, GU10
 A++ E

▼ **81690270**
 černý nikel/chrom, kov
 Ø 70
 3 W, 230 V, IP20, GU10
 A++ E

▼ **81690273**
 černý nikel/chrom, kov
 →640
 4x 3 W, 230 V, IP20, GU10
 A++ E

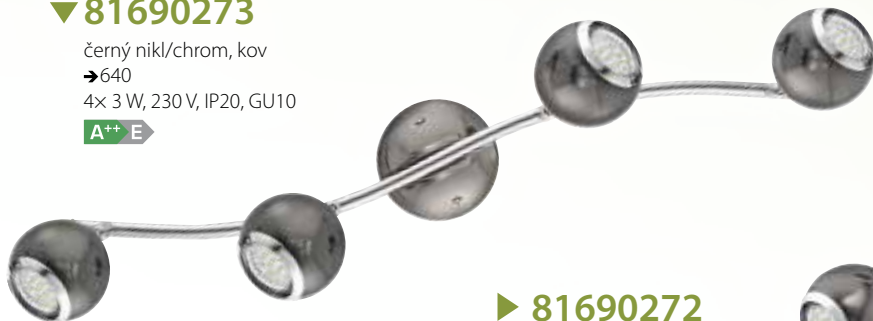

▶ **81690272**
 černý nikel/chrom, kov
 Ø 290
 3x 3 W, 230 V, IP20, GU10
 A++ E



▼ **81491271**
 bílá/chrom, kov
 Ø 290
 3x 3 W, 230 V, IP20, GU10
 A++ E



▲ **81693112**
 bílá/chrom, kov
 ↑660 →700
 5x 3 W, 230 V, IP20, GU10
 A++ E



▼ **81750105**
 bílá/chrom, kov
 →640
 4x 3 W, 230 V, IP20, GU10
 A++ E



▼ **81750546**
 bílá/chrom, kov
 →365
 2x 3 W, 230 V, IP20, GU10
 A++ E



◀ **81752800**
 matný nikel/chrom, kov
 ↑660 →700
 5x 3 W, 230 V, IP20, GU10
 A++ E

Vše skladem



◀ 81891779

matný nikl, kov
 ↑130 →900 Ø60
 4× 6 W, 230 V, IP20, GU10
 A++ A

▼ 81891777

matný nikl, kov
 ↑130 →80 Ø57
 6 W, 230 V, IP20, GU10
 A++ A



▲ 81891778

matný nikl, kov
 ↑130 →600 Ø60
 3× 6 W, 230 V, IP20, GU10
 A++ A



▲ 81779457

bílá, kov
 ↑230 →1770
 6× 6 W/3000 K/3300 lm, 230 V, IP20, LED



A+ LED

◀ 81783175

bílá, kov
 ↑95 →285
 2× 6 W/3000 K/1100 lm, 230 V, IP20, LED
 A+ LED



▶ 81782867

bílá, kov
 ↑200 →815
 4× 6 W/3000 K/2200 lm, 230 V, IP20, LED



A+ LED



► **82386702**

hnědá/bílá, kov/dřevo
 ↑165 →50
 10 W, 230 V, IP20, E27

A++ E



► **82498222**

hnědá/bílá, kov/dřevo
 ↑300 →50
 2× 60 W, 230 V, IP20, E27

A++ E



◀ **82498224**

hnědá/černá, kov/dřevo
 ↑480 →50
 4× 60 W, 230 V, IP20, E27

A++ E



► **82498223**

hnědá/černá, kov/dřevo
 ↑480 →50
 3× 60 W, 230 V, IP20, E27

A++ E





◀ **81891782**

nikl-antika/krémová, kov
 Ø 100
 3,3 W, 230 V, IP20, GU10

A++ B



▲ **81891784**

nikl-antika/krémová, kov
 ↑65 →595
 3× 3,3 W, 230 V, IP20, GU10

A++ B



◀ **81891783**

nikl-antika/krémová, kov
 ↑65 →370
 2× 3,3 W, 230 V, IP20, GU10

A++ B



▲ **81891785**

nikl-antika/krémová, kov
 ↑65 →770
 4× 3,3 W, 230 V, IP20, GU10

A++ B



◀ 81290782

bílá, hliník
 ↑82 →560 ↗60
 4x 4,5 W/2700 K/2000 lm, 230 V, IP20, LED

☑
 A+ LED



▲ 81290780

bílá, hliník
 ↑82 Ø 198
 3x 4,5 W/2700 K/1500 lm, 230 V, IP20, LED

☑
 A+ LED

▲ 81290778

bílá, hliník
 ↑82 →118 ↗60
 4,5 W/2700 K/500 lm, 230 V, IP20, LED

☑
 A+ LED

▲ 81295924

bílá, hliník
 ↑82 →198 ↗60
 2x 4,5 W/2700 K/1000 lm, 230 V, IP20, LED

☑
 A+ LED



▲ 82498234

černá, kov
 ↑82 →628 ↗122
 4x 5,5 W, 230 V, IP20, GU10

A++ E



◀ 82498233

černá, kov
 ↑82 Ø 224
 3x 5,5 W, 230 V, IP20, GU10

A++ E



▶ 81798953

černá, kov
 ↑82 →240 ↗122
 2x 5,5 W, 230 V, IP20, GU10

A++ E



▲ 82293760

černá, kov
 ↑82 →138 ↗100
 5,5 W, 230 V, IP20, GU10

A++ E



◀ **82296288**

hnědá patina/černá/vzhled zinku, kov/dřevo

↑160 →160

40 W, 230 V, IP20, E27

A++ E

▶ **82292700**

hnědá patina/černá/vzhled zinku, kov/dřevo

↑475 ↗90

2x 40 W, 230 V, IP20, E27



A++ E



◀ **82498225**

hnědá patina/černá/vzhled zinku, kov/dřevo

↑450 →450

40 W, 230 V, IP20, E27

A++ E



▲ **82296287**

hnědá patina/černá/vzhled zinku, kov/dřevo

↑790 ↗90

3x 40 W, 230 V, IP20, E27

A++ E

▶ **81292340**

bronz, sklo/kov
 ↗145 ↻470
 5x 40 W, 230 V, IP20, E14
 A++ E

▲ **81399140**

bronz, sklo/kov
 ↑205 ↻80
 40 W, 230 V, IP20, E14
 A++ E

◀ **81292337**

bronz, sklo/kov
 ↑110 ↻80
 40 W, 230 V, IP20, E14
 A++ E

▲ **81292338**

bronz, sklo/kov
 ↑160 ↻350
 2x 40 W, 230 V, IP20, E14
 A++ E

▲ **81292339**

bronz, sklo/kov
 ↑160 ↻600
 3x 40 W, 230 V, IP20, E14
 A++ E

Vše skladem

▼ **81281507**

bronz, sklo/kov
 ↑160 ↻700
 4x 40 W, 230 V, IP20, E14
 A++ E





◀ **80963235**

matný chrom, sklo/kov
 ↑110 →80
 40 W, 230 V, IP20, E14



A++ E

▶ **80963236**

matný chrom, sklo/kov
 ↑160 →350
 2× 40 W, 230 V, IP20, E14



A++ E



▲ **81275763**

matný chrom, sklo/kov
 ↑160 →600
 3× 40 W, 230 V, IP20, E14



A++ E

▼ **80963237**

matný chrom, sklo/kov
 ↑160 →700
 4× 40 W, 230 V, IP20, E14



A++ E





◀ **81891794**
 bílá/buk, kov
 ↑130 Ø70
 40 W, 230 V, IP20, E14
 A++ E



▲ **81891795**
 bílá/buk, kov
 →290 Ø70
 2x 40 W, 230 V, IP20, E14
 A++ E



▲ **81891796**
 bílá/buk, kov
 →480 Ø70
 3x 40 W, 230 V, IP20, E14

 A++ E

▼ **81891799**
 bílá/buk, kov
 →1550 Ø70
 6x 40 W, 230 V, IP20, E14
 A++ E



◀ **81891797**
 bílá/buk, kov
 →400 Ø70
 3x 40 W, 230 V, IP20, E14

 A++ E

▼ **81891798**
 bílá/buk, kov
 →720 Ø70
 4x 40 W, 230 V, IP20, E14
 A++ E





▲ **81754047**

matný nikl, kov
 ↑65 →285
 2x 3 W, 230 V, IP20, GU10



A+

▶ **81694771**

matný nikl, kov
 Ø60
 3 W, 230 V, IP20, GU10



A+



▼ **81754048**

matný nikl, kov
 ↑65 →485
 3x 3 W, 230 V, IP20, GU10



A+



▲ **81586181**

matný nikl, kov
 ↑65 →685
 4x 3 W, 230 V, IP20, GU10



A+



▲ **81586182**

matný nikl, kov
 ↑65 →1050
 6x 3 W, 230 V, IP20, GU10



A+



▲ 81783159

bílá/chrom, kov/plast
 Ø 110
 5,4 W/3000 K/640 lm, 230 V, IP20, LED

A++ A LED



▲ 81783160

bílá/chrom, kov/plast
 ↑360 →120
 2x 5,4 W/3000 K/1280 lm, 230 V, IP20, LED

A++ A LED



▲ 81783161

bílá/chrom, kov/plast
 ↑560 →130
 3x 5,4 W/3000 K/1920 lm, 230 V, IP20, LED

A++ A LED



▲ 81770739

bílá/chrom, kov/plast
 ↑760 →130
 4x 5,4 W/3000 K/2560 lm, 230 V, IP20, LED

A++ A LED



▲ 81783162

bílá/chrom, kov/plast
 ↑1595 →90
 6x 5,4 W/3000 K/3840 lm, 230 V, IP20, LED

A++ A LED



▲ **82498227**

bílá-hliníková/černá, kov
 ↑115 →120 ↗85
 5 W, 230 V, IP20, GU10

A++ E



◀ **82498228**

bílá-hliníková/černá, kov
 ↑115 →270 ↗85
 2× 5 W, 230 V, IP20, GU10

A++ E



◀ **82498229**

bílá-hliníková/černá, kov
 ↑115 →410 ↗85
 3× 5 W, 230 V, IP20, GU10

A++ E



▶ **82498231**

bílá-hliníková/černá, kov
 ↑115 →550 ↗85
 4× 5 W, 230 V, IP20, GU10

A++ E



▲ **82498232**

bílá-hliníková/černá, kov
 ↑115 →830 ↗85
 6× 5 W, 230 V, IP20, GU10

A++ E



▲ **81290850**

matný nikl, sklo/kov
 ↑70 →500
 3× 40 W, 230 V, IP20, E14



A++ E

▶ **81274371**

matný nikl, sklo/kov
 ↑190 →70
 40 W, 230 V, IP20, E14



A++ E



◀ **81274373**

matný nikl, sklo/kov
 ↑70 →300
 2× 40 W, 230 V, IP20, E14



A++ E

▶ **81274374**

matný nikl, sklo/kov
 Ø 265
 3× 40 W, 230 V, IP20, E14



A++ E





▶ **81783837**

antická hnědá, kov
 ↑160
 15 W, 230 V, IP20, E14
 A++ E



▲ **81783842**

antická hnědá, kov
 Ø300
 4x 40 W, 230 V, IP20, E14
 A++ E



◀ **81783838**

antická hnědá, kov
 →300
 2x 40 W, 230 V, IP20, E14
 A++ E



▲ **81783840**

antická hnědá, kov
 →525
 3x 40 W, 230 V, IP20, E14
 A++ E



▲ **81783843**

antická bílá, kov
 ↑160
 15 W, 230 V, IP20, E14
 A++ E

▼ **81783844**

antická bílá, kov
 →300
 2x 40 W, 230 V, IP20, E14
 A++ E

▲ **81783846**

antická bílá, kov
 Ø300
 4x 40 W, 230 V, IP20, E14
 A++ E

▼ **81783845**

antická bílá, kov
 →525
 3x 40 W, 230 V, IP20, E14
 A++ E



Vše skladem



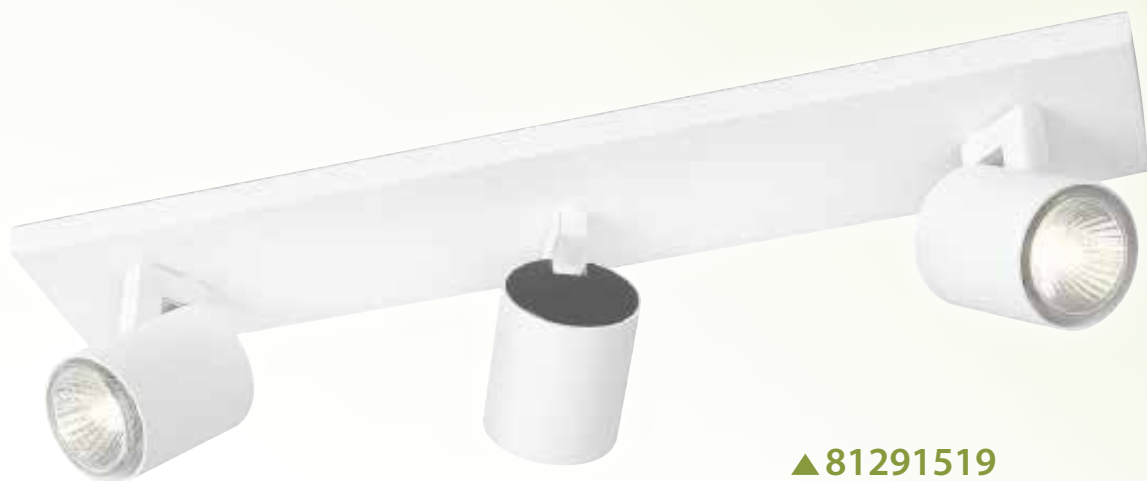

▲ 81291519

bílá, kov
 ↑109 →480 ↗90
 3× 35 W, 230 V, IP20, GU10
 A+ E



▲ 81773320

bílá, kov
 ↑109 →305 ↗90
 2× 35 W, 230 V, IP20, GU10
 A+ E



▲ 81490871

bílá, kov
 ↑107 →110
 35 W, 230 V, IP20, GU10
 A+ E



▲ 81588830

chromová, kov
 ↑109 →305 ↗90
 2× 35 W, 230 V, IP20, GU10

 A+ E

▼ 81681376

chromová, kov
 ↑109 →480 ↗90
 3× 35 W, 230 V, IP20, GU10

 A+ E



▶ **82384254**

matná černá/šampaňská, kov
 →430
 3× 35 W, 230 V, IP20, GU10

A++ E



◀ **82384253**

matná černá/šampaňská, kov
 →155
 35 W, 230 V, IP20, GU10

A++ E

▲ **82393828**

matná černá/šampaňská, kov
 →280
 2× 35 W, 230 V, IP20, GU10



A++ E



▲ **82393829**

matná černá/šampaňská, kov
 ↑250 →250
 4× 35 W, 230 V, IP20, GU10



A++ E

▲ **82498249**

dub, kov
 ↑260 →260
 4× 35 W, 230 V, IP20, GU10

A++ E

▶ **82498248**

dub, kov
 Ø 320
 3× 35 W, 230 V, IP20, GU10

A++ E



▲ **82498247**

dub, kov
 →320
 2× 35 W, 230 V, IP20, GU10

A++ E



◀ **82498246**

dub, kov
 →110
 35 W, 230 V, IP20, GU10

A++ E



▲ 82498272

černá/bílá, kov
 ↑215 →420 ↗120
 2x 40 W, 230 V, IP20, E14

A++ E



▲ 82394309

černá/bílá, kov
 ↑200 ↗120
 28 W, 230 V, IP20, E14



A++ E



▲ 82394310

černá/bílá, kov
 ↑215 →820 ↗120
 4x 40 W, 230 V, IP20, E14



A++ E



◀ 82498274

černá, kov
 →65 ↗105
 28 W, 230 V, IP20, E14

A++ E



▲ 82498275

černá, kov
 →365 ↗150
 2x 40 W, 230 V, IP20, E14

A++ E

▶ 82498276

černá, kov
 →640 ↗150
 4x 40 W, 230 V, IP20, E14

A++ E





◀ 81596994

chrom, plast
 ↑60 →120
 3 W, 230 V, IP20, GU10
 A++ B

▶ 81596638

chrom, plast
 ↑70 →390
 2× 3 W, 230 V, IP20, GU10
 A++ B



▲ 81690295

chrom, plast
 ↑70 →780
 4× 3 W, 230 V, IP20, GU10



A++ B

▶ 81690294

chrom, plast
 ↑70 →585
 3× 3 W, 230 V, IP20, GU10
 A++ B





▲ 81770714

bílá/chrom, kov
 ↑70 →300
 2× 5 W, 230 V, IP20, GU10
 A++ B

▼ 81770716

bílá/chrom, kov
 ↑240 →260
 4× 5 W, 230 V, IP20, GU10
 A++ B



▲ 81770715

bílá/chrom, kov
 ↑70 →460
 3× 5 W, 230 V, IP20, GU10
 A++ B



▲ 81770713

bílá/chrom, kov
 ↑60 →120
 5 W, 230 V, IP20, GU10
 A++ B

Vše skladem



► 81770720

černá/chrom, kov
 ↑240 →260
 4× 5 W, 230 V, IP20, GU10
 A++ B



▲ 81770719

černá/chrom, kov
 ↑70 →460
 3× 5 W, 230 V, IP20, GU10
 A++ B

▲ 81770717

černá/chrom, kov
 ↑60 →120
 5 W, 230 V, IP20, GU10
 A++ B

► 81770718

černá/chrom, kov
 ↑70 →300
 2× 5 W, 230 V, IP20, GU10
 A++ B





▲ 81491246

bílá/chrom, kov
 ↑70 →780
 4× 5 W, 230 V, IP20, GU10

A++ B



▶ 81599027

bílá/chrom, kov
 ↑70 →390
 2× 5 W, 230 V, IP20, GU10

A++ B

▲ 81693113

bílá/chrom, kov
 ↑70 →165
 5 W, 230 V, IP20, GU10

A++ B



▲ 81756172

bílá/chrom, kov
 ↑70 →580
 3× 5 W, 230 V, IP20, GU10

A++ B

Vše skladem



▼ 81693114

černá/matný nikl, kov
 ↑70 →780
 4× 5 W, 230 V, IP20, GU10

A++ B



▶ 81495969

černá/matný nikl, kov
 ↑70 →165
 5 W, 230 V, IP20, GU10

A++ B



▲ 81752989

černá/matný nikl, kov
 ↑70 →580
 3× 5 W, 230 V, IP20, GU10

A++ B



▲ 81751980

černá/matný nikl, kov
 ↑70 →390
 2× 5 W, 230 V, IP20, GU10

A++ B

▲ 82398489

černá/zlatá, kov
↑110 ↗85
25 W, 230 V, IP20, GU10

A++ E



▶ 82599726

černá/zlatá, kov
↑395 Ø60
5 W, 230 V, IP20, GU10
A++ E

◀ 82499214

černá/zlatá, kov
↑1370 Ø60
5 W, 230 V, IP20, GU10
A++ E



▼ **82499211**

černá/krémová/hnědá, dřevo/kov

↑1400 Ø 230

28 W, 230 V, IP20, E27

A++ E

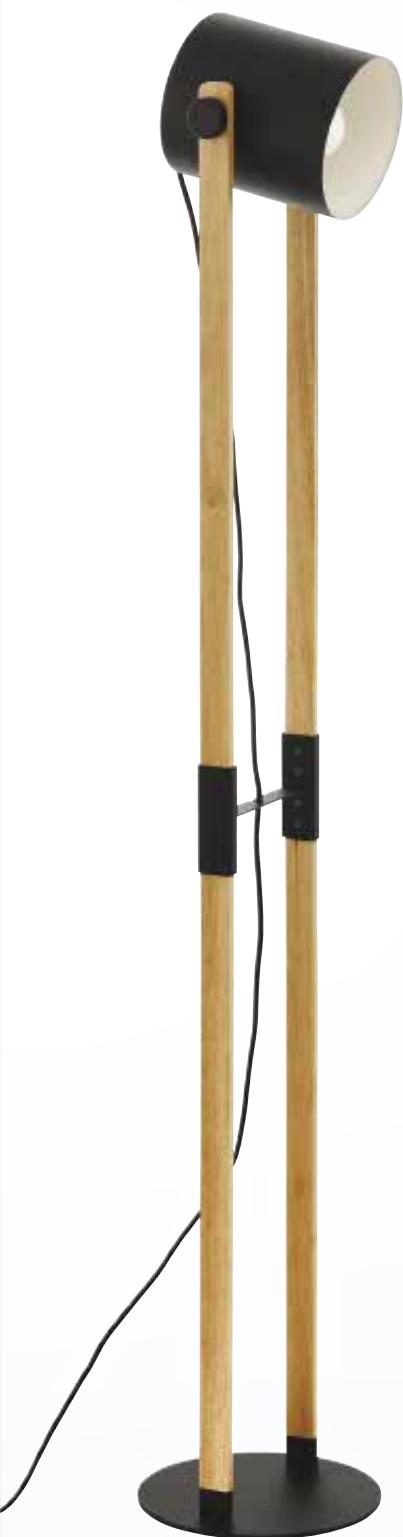

◀ **82499210**

přírodní/černá/bílá, dřevo/kov/textil

↑535 Ø 260

40 W, 230 V, IP20, E27

A++ E



◀ **82499208**

šedá/bílá, dřevo/textil

↑390 Ø 200

40 W, 230 V, IP20, E14

A++ E



▶ **82499209**

šedá/bílá, dřevo/textil

↑355 Ø 250

40 W, 230 V, IP20, E14

A++ E



▶ **82499212**

hnědá patina/černá/vzhled zinku, dřevo/kov

↑1400 Ø 230

2x 40 W, 230 V, IP20, E27

A++ E





◀ **81892922**

černá/zlatá, kov
 ↑1360 Ø300
 15 W, 230 V, IP20, E27



A++ E



◀ **81892921**

černá/zlatá, kov
 ↑420 Ø150
 15 W, 230 V, IP20, E27



A++ E

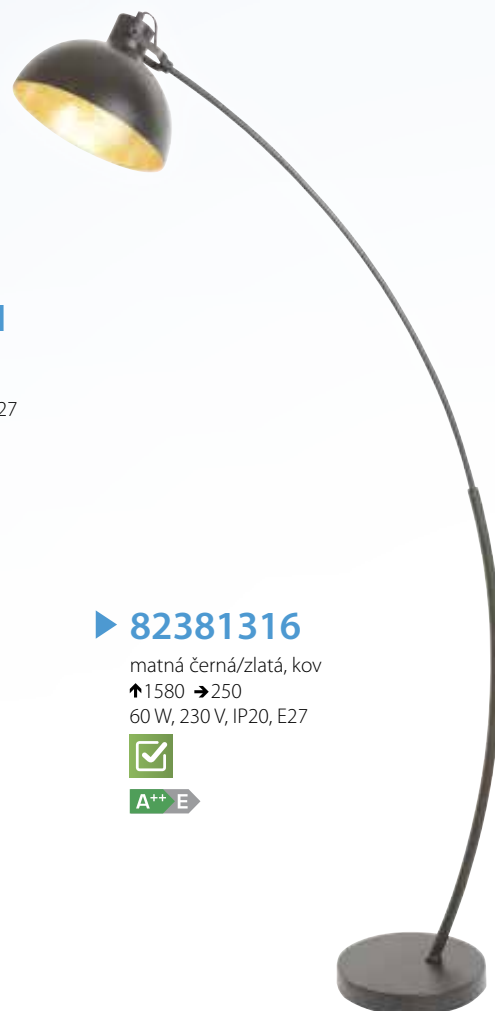

▶ **82381316**

matná černá/zlatá, kov
 ↑1580 →250
 60 W, 230 V, IP20, E27



A++ E

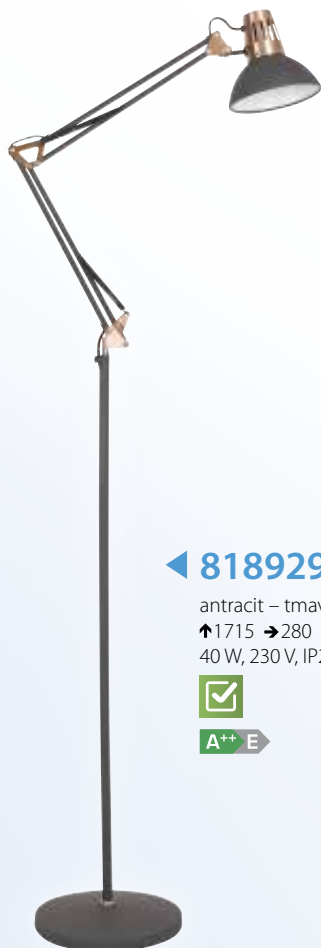

◀ **81892923**

antracit – tmavě šedá/měď, kov
 ↑1715 →280
 40 W, 230 V, IP20, E27



A++ E

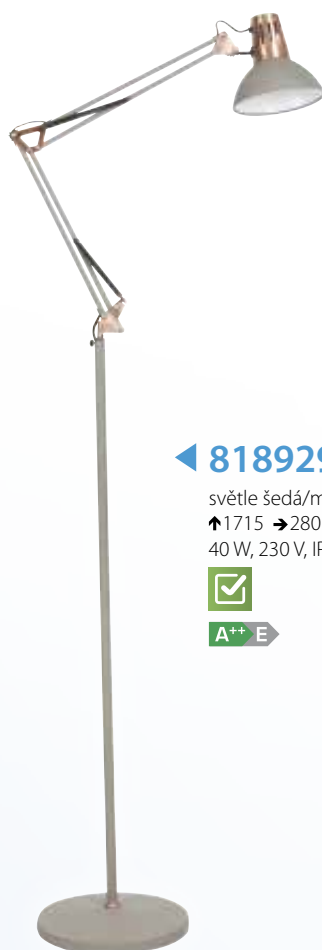

◀ **81892924**

světle šedá/měď, kov
 ↑1715 →280
 40 W, 230 V, IP20, E27



A++ E

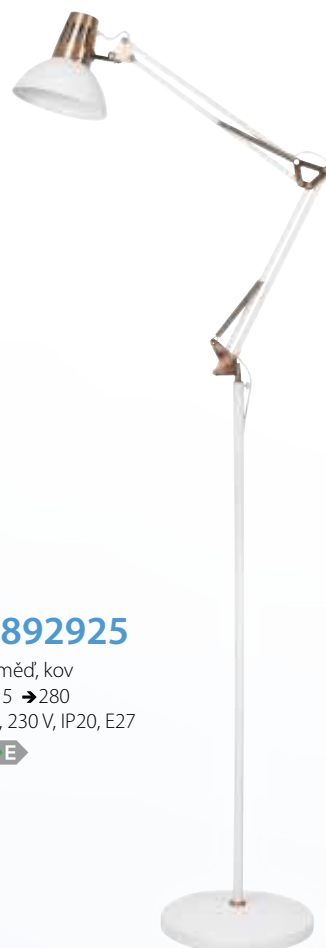

▶ **81892925**

bílá/měď, kov
 ↑1715 →280
 40 W, 230 V, IP20, E27



A++ E

◀ 82499214

černá/zlatá, kov
 ↑1370 Ø60
 5 W, 230 V, IP20, GU10
 A++ E



▼ 82499215

bílá/stříbrná, kov
 ↑395 Ø60
 5 W, 230 V, IP20, GU10
 A++ E



▶ 82499218

černá/bílá, kov/plast
 ↑1600
 27 W/3000 K/2600 lm, 230 V, IP20, LED



◀ 82499217

černá/čirá/bílá, kov/plast
 ↑1595
 25 W/3000 K/2150 lm, 230 V, IP20, LED



▲ 82499216

chrom/bílá, kov/plast
 ↑370 Ø150
 1x 3 W + 1x 4 W/3000 K/330 lm + 45 lm, 230 V, IP20, LED





◀ 81595551

matný nikl, sklo/kov
 ↑1800 Ø250
 20 W + 2,5 W/3000 K/1950 lm + 250 lm, 230 V, IP20, LED



A++ LED



▶ 43994663

matný nikl, sklo/kov
 ↑1800 Ø280
 230 W + 33 W, 230 V, IP20, R7S + G9



C-D



◀ 81595552

chrom, sklo/kov
 ↑1800 Ø250
 20 W + 2,5 W/3000 K/1950 lm + 250 lm, 230 V, IP20, LED



A++ LED



◀ 81398291

matný nikl, kov/sklo
 ↑1765 Ø230
 60 W + 25 W, 230 V, IP20, E27 + E14



A++ E



▶ 81591656

oranžová, kov/sklo
 ↑1720 Ø230
 60 W + 40 W, 230 V, IP20, E27 + E14



A++ E

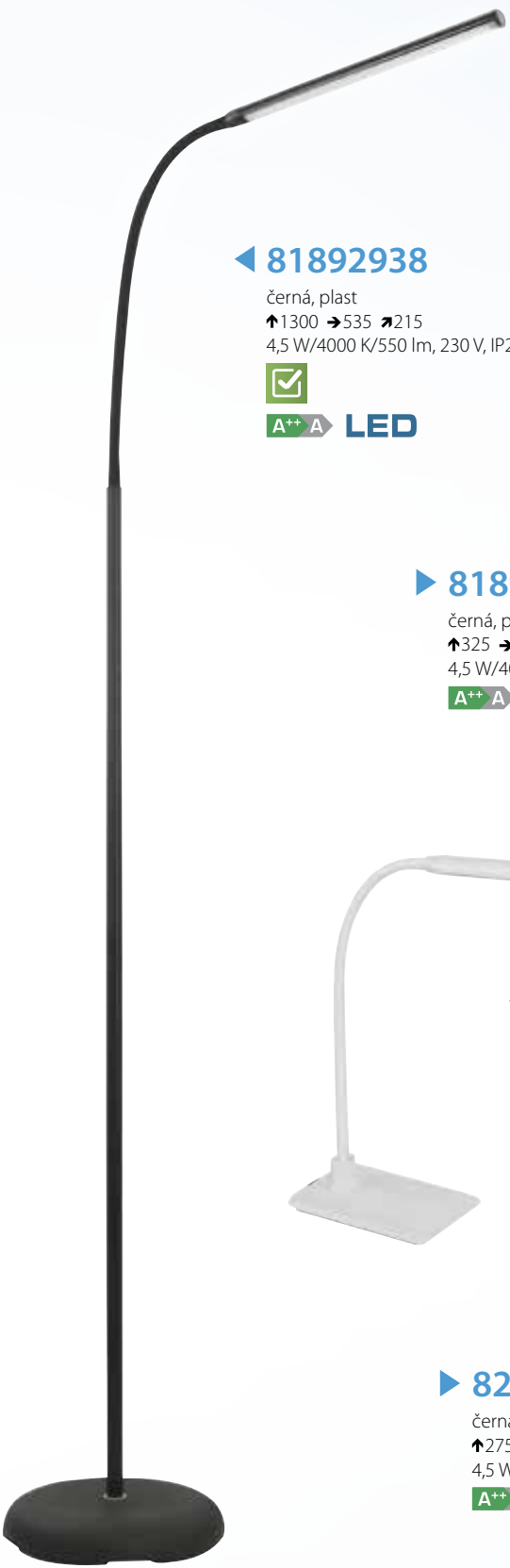

◀ 81892938

černá, plast
 ↑1300 →535 ↗215
 4,5 W/4000 K/550 lm, 230 V, IP20, LED

☑
 A++ A LED

▼ 81892937

bílá, plast
 ↑1300 →535 ↗215
 4,5 W/4000 K/550 lm, 230 V, IP20, LED

☑
 A++ A LED

▶ 81892940

černá, plast
 ↑325 →480 ↗120
 4,5 W/4000 K/550 lm, 230 V, IP20, LED

A++ A LED



◀ 81892939

bílá, plast
 ↑325 →480 ↗120
 4,5 W/4000 K/550 lm, 230 V, IP20, LED

A++ A LED



▶ 82386382

černá, plast
 ↑275 →450 ↗65
 4,5 W/4000K/550 lm, 230 V, IP20, LED

A++ A LED



◀ 82499219

bílá, plast
 ↑275 →450 ↗65
 4,5 W/4000K/550 lm, 230 V, IP20, LED

A++ A LED





▲ 82499221

bílá, textil/keramika
 ↑460 Ø240
 60 W, 230 V, IP20, E27
 A++ E



▲ 81783847

běžová/bílá, textil/keramika
 ↑350 Ø245
 40 W, 230 V, IP20, E14



A++ E



◀ 81783848

hnědá/bílá, textil/keramika
 ↑470 →330 ↗205
 40 W, 230 V, IP20, E27



A++ E



▲ 82499223

bílá, textil/keramika
 ↑400 →330
 60 W, 230 V, IP20, E27

A++ E



▲ 82499225

modrá, kov/textil
 ↑310 Ø140
 40 W, 230 V, IP20, E14
 A++ E

▶ 82499227

bílá, keramika/textil
 ↑300 Ø130
 40 W, 230 V, IP20, E14
 A++ E



◀ 82499224

růžová, kov/textil
 ↑310 Ø140
 40 W, 230 V, IP20, E14
 A++ E



◀ 81491894

bílá, keramika/textil
 ↑190 Ø200
 40 W, 230 V, IP20, E14

 A++ E

▼ 82499229

bílá, keramika/textil
 ↑300 Ø130
 40 W, 230 V, IP20, E14
 A++ E



▶ 81491893

oranžová, keramika/textil
 ↑190 Ø200
 40 W, 230 V, IP20, E14

 A++ E



▶ **81790336**

šedá, keramika/textil
 ↑260 Ø 180
 40 W, 230 V, IP20, E14



A++ E



▼ **81790333**

běžová, keramika/textil
 ↑260 Ø 180
 40 W, 230 V, IP20, E14



A++ E



◀ **81793987**

bílá/běžová, keramika/textil
 ↑250 Ø 205
 40 W, 230 V, IP20, E14

A++ E



▼ **82499231**

krémová, keramika/textil
 ↑280 Ø 170
 40 W, 230 V, IP20, E14

A++ E



▼ **82499232**

hnědá, keramika/textil
 ↑280 Ø 170
 40 W, 230 V, IP20, E14

A++ E



▲ **82499230**

modrá/bílá, keramika/textil
 ↑250 Ø 205
 40 W, 230 V, IP20, E14

A++ E



◀ 81890952

hnědá, kov/plast
 ↑420
 5 W/4000 K/300 lm, 230 V, IP20, LED



A+ LED



▶ 81890949

zelená, kov/plast
 ↑405
 6 W/2700 K/4000 K/6000 K/400 lm, 230 V, IP20, LED



A+ LED



▶ 81890950

černá, kov/plast
 ↑405
 6 W/2700 K/4000 K/6000 K/400 lm, 230 V, IP20, LED



A+ LED



◀ 81892935

žlutá, kov/plast
 ↑410
 5 W/4000 K/400 lm, 230 V, IP20, LED

A+ LED

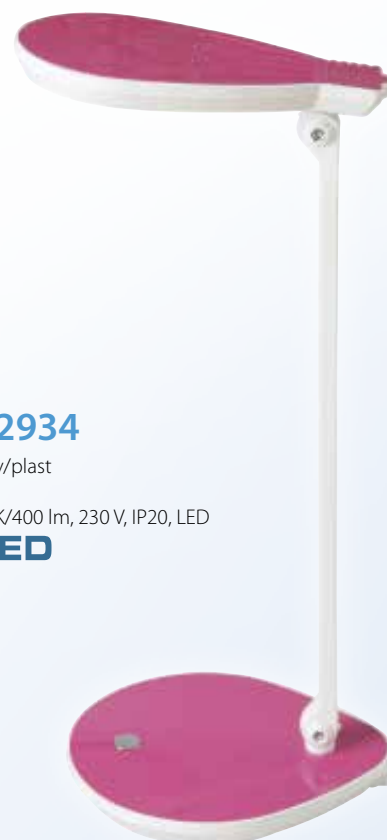

▶ 81892934

růžová, kov/plast
 ↑410
 5 W/4000 K/400 lm, 230 V, IP20, LED

A+ LED

Vše skladem





◀ 81293010

zelená, kov/plast
 ↑430 →150
 40 W, 230 V, IP20, E14



◀ 81297034

stříbrná, kov/plast
 ↑430 →150
 40 W, 230 V, IP20, E14



▶ 81297403

růžová, kov/plast
 ↑430 →150
 40 W, 230 V, IP20, E14



▶ 81497807

červená, kov/plast
 ↑300 →125
 40 W, 230 V, IP20, E27



◀ 81497805

černá, kov/plast
 ↑300 →125
 40 W, 230 V, IP20, E27



▶ 81497818

modrá, kov/plast
 ↑300 →125
 40 W, 230 V, IP20, E27



◀ 81497806

bílá, kov/plast
 ↑300 →125
 40 W, 230 V, IP20, E27





◀ **81581992**

bílá, plast/guma
 ↑305 →120 ↗140
 3 W/6200 K/300 lm, 230 V, IP20, LED



A++ LED

▶ **81587950**

černá, plast/guma
 ↑305 →120 ↗140
 3 W/6200 K/300 lm, 230 V, IP20, LED



A++ LED



▼ **81581993**

červená, plast/guma
 ↑305 →120 ↗140
 3 W/6200 K/300 lm, 230 V, IP20, LED



A++ LED



◀ **81749213**

černá, plast
 ↑520 →320
 4,5 W/3000 K/480 lm, 230 V, IP20, LED



A+ LED



▶ **81776555**

champaň, plast
 ↑520 →320
 4,5 W/3000 K/480 lm, 230 V, IP20, LED



A+ LED



◀ **81749210**

bílá, plast
 ↑520 →320
 4,5 W/3000 K/480 lm, 230 V, IP20, LED



A+ LED



▶ **81691755**

červená, plast
 ↑520 →320
 4,5 W/3000 K/480 lm, 230 V, IP20, LED



A+ LED





◀ **81398256**

černá, kov
 ↑490
 60 W, 230 V, IP20, E27
A++ E



▶ **81398255**

bílá, kov
 ↑490
 60 W, 230 V, IP20, E27
A++ E

Vše skladem



▶ **81492025**

stříbrná, kov
 ↑490
 60 W, 230 V, IP20, E27
A++ E



▶ **81764407**

zelená, kov
 ↑490
 60 W, 230 V, IP20, E27
A++ E



▶ **81764408**

růžová, kov
 ↑490
 60 W, 230 V, IP20, E27
A++ E



◀ 81888842

bílá, plast/kov
 ↑2x 460
 22 W, 230 V, IP20, T5

B

▼ 81263436

bílá, plast/kov
 ↑2x 450
 22 W, 230 V, IP20, G10q T9

A+



▼ 82393841

růžová, kov
 ↑330 →105
 25 W, 230 V, IP20, E14

A++ E



◀ 82393840

modrá, kov
 ↑330 →105
 25 W, 230 V, IP20, E14

A++ E

Vše skladem





◀ 81892932

černá, plast
 ↑350 →130 Ø30
 4,5 W/3000 K/330 lm, 230 V, IP20, LED



A+ LED



▶ 81892931

bílá, plast
 ↑350 →130 Ø30
 4,5 W/3000 K/330 lm, 230 V, IP20, LED



A+ LED



◀ 81498444

bílá/stříbrná, plast
 ↑390 →360 Ø180
 8 W/5000 K/310 lm, 230 V, IP20, LED



A+ LED



▲ 82499235

bílá, kov/plast
 ↑170 →100 Ø70
 5 W/3000 K/360 lm, 230 V, IP20, LED

A+ LED



▲ 82499236

černá, kov/plast
 ↑170 →100 Ø70
 5 W/3000 K/360 lm, 230 V, IP20, LED

A+ LED



▶ 81591672

černá/stříbrná, plast
 ↑390 →360 Ø180
 8 W/5000 K/310 lm, 230 V, IP20, LED



A+ LED



◀ 81750585

černá, plast
 ↑500 →200 ↗150
 12 W/3000–6500 K/700 lm, 230 V, IP20, LED



A+ LED

▶ 81750584

bílá, plast
 ↑500 →200 ↗150
 12 W/3000–6500 K/700 lm, 230 V, IP20, LED



A+ LED



◀ 81775285

bílá, plast/kov
 ↑900 →580
 21 W/6500 K/1000 lm, 230 V, IP20, LED



A+ LED



◀ 81691775

černá, plast
 ↑430 →300
 9 W/3000 K/534 lm, 230 V, IP20, LED



A+ LED

▶ 81691774

bílá, plast
 ↑430 →300
 9 W/3000 K/534 lm, 230 V, IP20, LED



A+ LED





► **81690330**

chrom/bílá, sklo/kov

↑70 →450 ↗125

3x 4,5 W/3000 K/1440 lm, 230 V, IP44, LED



A+ LED





◀ 81768999

matný nikl, plast/kov
 ↑40 →350 ↗75
 8 W/4000 K/770 lm, 230 V, IP44, LED
 A++ A LED



▶ 81752051

matný nikl, plast/kov
 ↑40 →600 ↗75
 16 W/4000 K/1500 lm, 230 V, IP44, LED



A++ A LED

▼ 81693108

matný nikl, plast/kov
 ↑40 →900 ↗75
 24 W/4000 K/2200 lm, 230 V, IP44, LED



A++ A LED



◀ 80991202

matný nikl, sklo/kov
 →460
 2x 40 W, 230 V, IP44, E14



A++ E

▶ 80991200

chrom, sklo/kov
 →460
 2x 40 W, 230 V, IP44, E14



A++ E





◀ **60998328**

bílá/chrom, sklo/kov
 →300 ↗50
 2× 33 W, 230 V, IP44, G9



▶ **80990927**

bílá/chrom, sklo/kov
 ↑120 →290 ↗90
 2× 40 W, 230 V, IP44, E14



A++ E



▶ **80990926**

bílá/chrom, sklo/kov
 →205 ↗80
 2× 40 W, 230 V, IP44, G9



C



▶ **80990925**

bílá/chrom, sklo/kov
 ↑140 →105
 40 W, 230 V, IP44, G9



C



▼ **80990928**

bílá/chrom, sklo/kov
 ↑105 →488
 2× 40 W, 230 V, IP44, E14



A++ E



▶ **81271296**

chrom, sklo/kov
 →630 ↗130
 14 W, 230 V, IP20, G5T5



A++ E



▲ **81491095**

bílá/lesklý chrom, plast/kov
 ↑63 →483 ↗67
 3x 2,5 W/2700 K/560 lm, 230 V, IP44, LED



A+ LED



▲ **81263534**

chrom, sklo/kov
 →920 ↗130
 21 W, 230 V, IP20, G5T5



A++ E

▼ **81786944**

bílá, opálové sklo/kov
 ↑105 →610 ↗75
 21 W/4000 K/2700 lm, 230 V, IP44, LED

A++ LED



▲ **81769596**

bílá, opálové sklo/kov
 ↑105 →610 ↗75
 21 W/3000 K/2590 lm, 230 V, IP44, LED

A++ LED

▶ **81294037**

chrom, plast/kov
 ↑70 →580
 24 W/3000 K/1980 lm, 230 V, IP44, LED

 **LED**



◀ **81690327**

chrom, plast/kov
 ↑70 →605
 3× 3,2 W/4000 K/900 lm, 230 V, IP44, LED



 **LED**



▶ **81690328**

matný nikl, plast/kov
 ↑70 →605
 3× 3,2 W/4000 K/900 lm, 230 V, IP44, LED



 **LED**



◀ **81776263**

chrom, plast/kov
 ↑40 →400
 7,4 W/4000 K/900 lm, 230 V, IP44, LED



 **LED**



▶ **81770253**

chrom, plast/kov
 ↑40 →600
 11 W/4000 K/1350 lm, 230 V, IP44, LED



 **LED**



▼ **81770750**

chrom, plast/kov
 ↑40 →780
 14 W/4000 K/1700 lm, 230 V, IP44, LED



 **LED**



▶ **81749221**

matný nikl, plast/kov
 ↑60 →255 ↗80
 5 W/3000 K/360 lm, 230 V, IP20, LED



A+ LED



▶ **81691777**

matný nikl, plast/kov
 ↑60 →580 ↗80
 10 W/3000 K/700 lm, 230 V, IP20, LED



A+ LED



▶ **81749222**

chrom, plast/kov
 ↑60 →255 ↗80
 5 W/3000 K/360 lm, 230 V, IP20, LED



A+ LED



◀ **81691776**

chrom, plast/kov
 ↑60 →580 ↗80
 10 W/3000 K/700 lm, 230 V, IP20, LED



A+ LED

▶ **81769191**

chrom, plast/kov
 ↑80 →490 ↗110
 12 W/4000 K/1180 lm, 230 V, IP44, LED



A+ LED





◀ 82095466

bronz, plast/kov
 ↑60 →486 ↗70
 12 W/4000 K/1180 lm, 230 V, IP44, LED



A+ LED

▶ 82384256

matná bílá, plast/kov
 ↑65 →490 ↗120
 12 W/3000 K/820 lm, 230 V, IP44, LED

A+ LED



◀ 81789296

chrom, plast/kov
 ↑60 →486 ↗70
 12 W/4000 K/1180 lm, 230 V, IP44, LED



A+ LED



▶ 82093936

bronz, plast/kov
 ↑70 →486 ↗100
 12 W/4000 K/1180 lm, 230 V, IP44, LED



A+ LED



◀ 82393843

matná bílá, plast/kov
 ↑65 →490 ↗95
 12 W/3000 K/820 lm, 230 V, IP44, LED



A+ LED





◀ **81754057**

chrom/bílá, sklo/kov
 ↑155 →70 ↗120
 2× 4,5 W/3000 K/960 lm, 230 V, IP44, LED



A+ LED

▼ **81690329**

chrom/bílá, sklo/kov
 ↑70 →300 ↗125
 2× 4,5 W/3000 K/960 lm, 230 V, IP44, LED

A+ LED



◀ **81690330**

chrom/bílá, sklo/kov
 ↑70 →450 ↗125
 3× 4,5 W/3000 K/1440 lm, 230 V, IP44, LED



A+ LED

▼ **81690331**

chrom/bílá, sklo/kov
 ↑320 →320 ↗70
 5× 4,5 W/3000 K/2400 lm, 230 V, IP44, LED

A+ LED



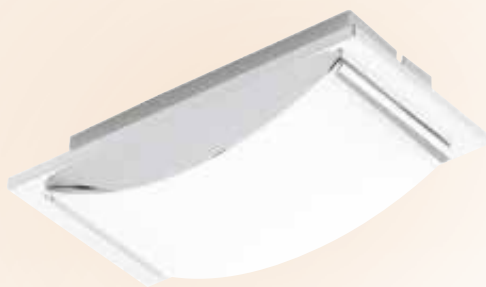

◀ **81770705**

chrom/bílá, sklo/kov
 ↑105 →210 ↻60
 5,4 W/3000 K/510 lm, 230 V, IP44, LED
 A+ LED

▼ **81770707**

chrom/bílá, sklo/kov
 ↑105 →630 ↻60
 3x 5,4 W/3000 K/1530 lm, 230 V, IP44, LED



A+ LED

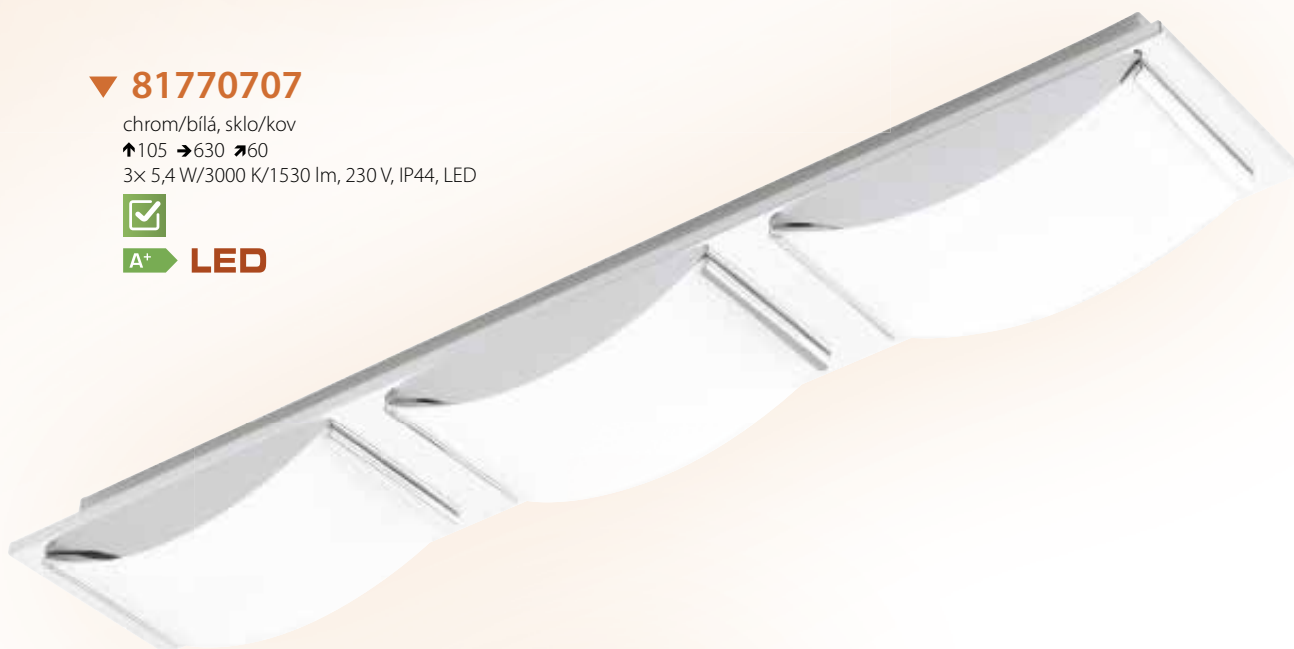

◀ **81770706**

chrom/bílá, sklo/kov
 ↑105 →420 ↻60
 2x 5,4 W/3000 K/1020 lm, 230 V, IP44, LED



A+ LED



▶ **81770708**

chrom/bílá, sklo/kov
 ↑320 →320 ↻60
 4x 5,4 W/3000 K/2040 lm, 230 V, IP44, LED



A+ LED





◀ 81287843

bronz, sklo/kov
 ↑125 →420 ↗180
 2x 40 W, 230 V, IP44, E14



A++ E



◀ 81295907

bronz, sklo/kov
 ↑125 →110 ↗180
 40 W, 230 V, IP44, E14



A++ E



▶ 82598525

bronz, sklo/kov
 ↑190 →140 ↗170
 6 W/3000 K/550 lm, 230 V, IP44, LED

A+ LED



▲ 82393846

bronz, sklo/kov
 ↑190 →140 ↗170
 6 W/3000 K/550 lm, 230 V, IP44, LED



A+ LED



◀ 82598526

bronz, kov/plast
 →400 ↗50
 2x 5 W/3000 K/900 lm, 230 V, IP44, LED

A+ LED

▶ 82384258

chrom, kov/plast
 →400 ↗50
 2x 5 W/4000 K/900 lm, 230 V, IP44, LED



A+ LED





◀ **81749641**

mléčná/bílá, plast
 ↗53 Ø 220
 15 W/3000 K/1050 lm, 230 V, IP44, LED
A LED

◀ **81749642**

mléčná/bílá, plast
 ↗53 Ø 220
 15 W/4000 K/1050 lm, 230 V, IP44, LED
A LED

◀ **81749643**

mléčná/bílá, plast
 ↗53 Ø 280
 24 W/3000 K/1600 lm, 230 V, IP44, LED
A LED

◀ **81749644**

mléčná/bílá, plast
 ↗53 Ø 280
 24 W/4000 K/1600 lm, 230 V, IP44, LED
A LED

Vše skladem



▶ **81749645**

mléčná/bílá, plast
 ↑220 → 220 ↗51
 15 W/3000 K/1050 lm, 230 V, IP44, LED
A LED

▶ **81749646**

mléčná/bílá, plast
 ↑220 → 220 ↗51
 15 W/4000 K/1050 lm, 230 V, IP44, LED
A LED

▶ **81749647**

mléčná/bílá, plast
 ↑280 → 280 ↗51
 24 W/3000 K/1600 lm, 230 V, IP44, LED
A LED

▶ **81749648**

mléčná/bílá, plast
 ↑280 → 280 ↗51
 24 W/4000 K/1600 lm, 230 V, IP44, LED
A LED





◀ **81766985**

chrom, sklo/kov
 Ø 225
 11 W/3000 K/1100 lm, 230 V, IP44, LED
A+ LED

▼ **81778269**

chrom, sklo/kov
 Ø 295
 24 W/3000 K/2500 lm, 230 V, IP44, LED
A+ LED



▲ **81771639**

chrom, sklo/kov
 Ø 420
 24 W/3000 K/2500 lm, 230 V, IP54, LED
A+ LED

▶ **81769521**

chrom, sklo/kov
 Ø 320
 16 W/3000 K/1600 lm, 230 V, IP54, LED
A+ LED



Vše skladem



▼ **81778268**

hliník/bílá, plast/kov
 Ø 300
 11 W/3000 K/1100 lm, 230 V, IP44, LED
A+ LED

▲ **81774439**

chrom/bílá, plast/kov
 Ø 385
 16 W/3000 K/1600 lm, 230 V, IP44, LED
A+ LED





◀ 81292701

bílá, plast/kov
 ↑66 Ø 364
 13 W/2700 K/1030 lm, 230 V, IP44, LED



A → LED

▶ 82598527

bílá, plast/kov
 Ø 315
 24 W/4000 K/1500 lm, 230 V, IP65, LED

A+ → LED



◀ 82393821

bílá, plast/kov
 Ø 375
 36 W/4000 K/2160 lm, 230 V, IP65, LED



A+ → LED

▶ 82381346

stříbrná/bílá, plast/kov
 ↑400 →400 ↗25
 24 W/3000 K/1500 lm, 230 V, IP44, LED



A → LED



◀ 147899

bílá, sklo
 ↑120 Ø 260
 20 W, 230 V, IP44, E27

A →

▲ 82498810

stříbrná/bílá, plast/kov
 ↑300 →300 ↗25
 18 W/3000 K/1200 lm, 230 V, IP44, LED



A → LED



◀ **81770748**

chrom, kov

↑40 →300 ↗300

22 W/3000 K/2200 lm, 230 V, IP44, LED

A+ LED



▶ **81770749**

chrom, kov

↑40 →300 ↗300

22 W/3000 K/2600 lm, 230 V, IP44, LED

A+ LED



◀ **81777719**

bílá, kov

↑40 →300 ↗300

22 W/3000 K/2200 lm, 230 V, IP44, LED

A+ LED

Vše skladem





◀ 81770746

chrom, kov/plast
 ↑30 Ø85
 2,7 W/3000 K/300 lm, 230 V, IP44, LED
 montážní otvor ø 74 mm
A++ LED

◀ 81770747

chrom, kov/plast
 ↑30 Ø85
 2,7 W/4000 K/360 lm, 230 V, IP44, LED
 montážní otvor ø 74 mm
A++ LED

▶ 81891529

bílá, kov/plast
 ↑30 Ø85
 2,7 W/3000 K/300 lm, 230 V, IP44, LED
 montážní otvor ø 74 mm
A++ LED

▶ 82388671

bílá, kov/plast
 ↑30 Ø85
 2,7 W/4000 K/360 lm, 230 V, IP44, LED
 montážní otvor ø 74 mm
A++ LED



◀ 81881969

chrom, kov/plast
 ↑30 Ø170
 10,9 W/3000 K/1200 lm, 230 V, IP44, LED
 montážní otvor ø 155 mm
A++ LED

◀ 81798697

chrom, kov/plast
 ↑30 Ø170
 10,9 W/4000 K/1350 lm, 230 V, IP44, LED
 montážní otvor ø 155 mm
A++ LED

Vše skladem



▶ 81798679

bílá, kov/plast
 ↑30 Ø170
 10,9 W/3000 K/1200 lm, 230 V, IP44, LED
 montážní otvor ø 155 mm
A++ LED

▶ 81890477

bílá, kov/plast
 ↑30 Ø170
 10,9 W/4000 K/1350 lm, 230 V, IP44, LED
 montážní otvor ø 155 mm
A++ LED



▶ **82399441**

chrom/čirá, kov/plast
↑300 Ø500
8x 3 W, 230 V, IP44, G9
A++ E



◀ 81799344

hnědá/bílá, kov/dřevo/plast

↑1300 →800 ↗200

13,6 W/3000 K/1080 lm, 230 V, IP20, LED

A++ A





◀ **82683333**

černá/bílá, kov
 ↑1100 Ø160
 60 W, 230 V, IP20, E27
 A++ E



▶ **82385054**

černá/bílá, kov
 ↑1500 Ø380
 60 W, 230 V, IP20, E27
 A++ E

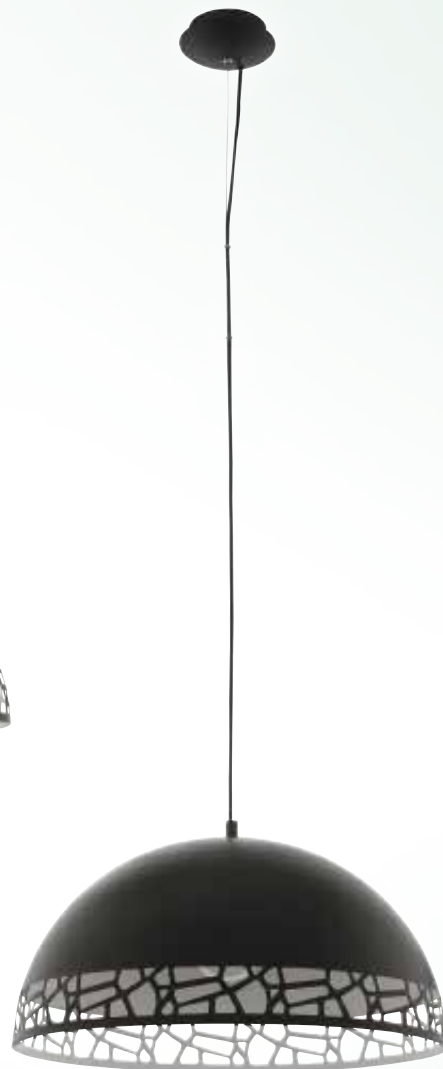

▲ **82496776**

černá/bílá, kov
 ↑1500 Ø530
 60 W, 230 V, IP20, E27
 A++ E



◀ **82683334**

černá/bílá, kov
 ↑1100 →800 ↗160
 3× 60 W, 230 V, IP20, E27
 A++ E

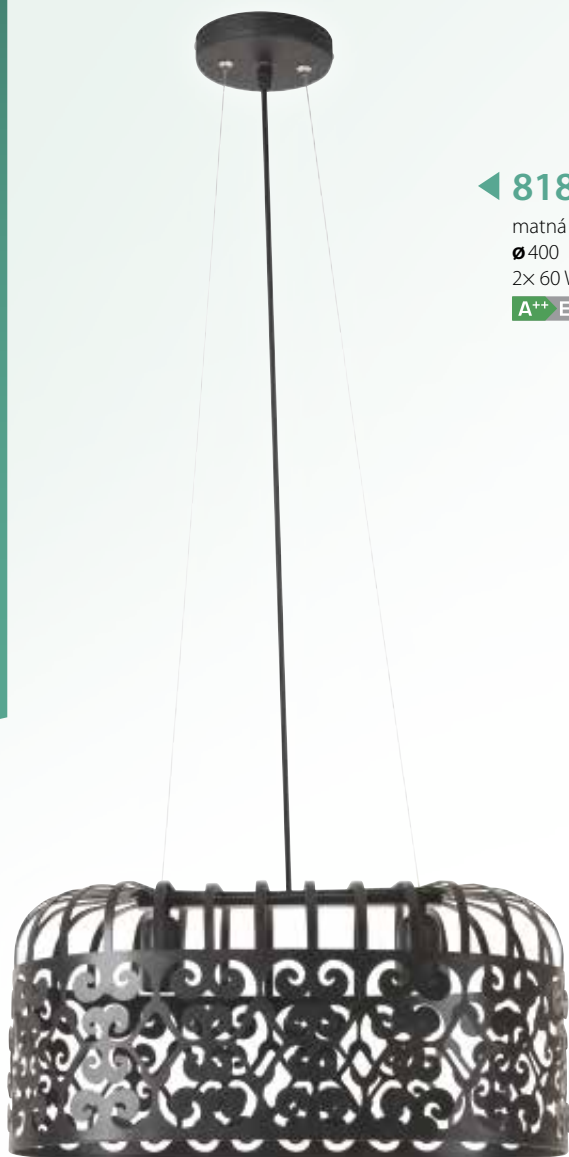

◀ 81892834

matná černá, kov
 Ø 400
 2x 60 W, 230 V, IP20, E27
 A++ E

▶ 81779303

krémová/borovice, kov
 ↑ 1100 Ø 350
 60 W, 230 V, IP20, E27
 A++ E

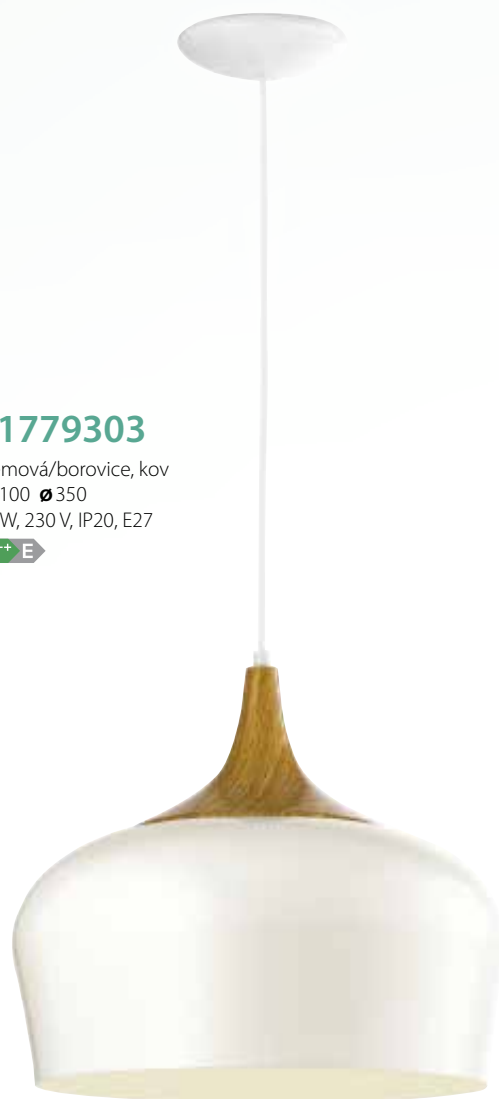

◀ 81892835

matná bílá, kov
 Ø 270
 3x 60 W, 230 V, IP20, E27

 A++ E

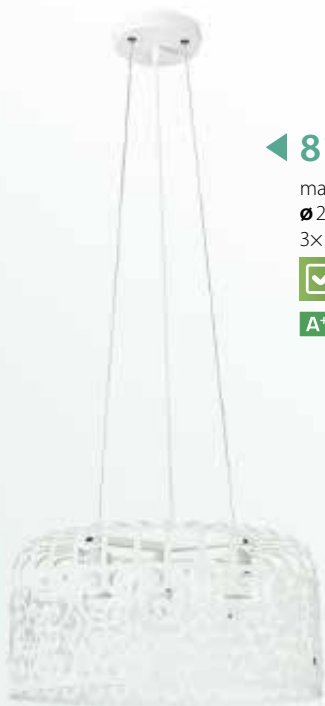

◀ 81892861

hnědá/krémová/borovice, kov
 ↑ 1100 Ø 350
 60 W, 230 V, IP20, E27
 A++ E

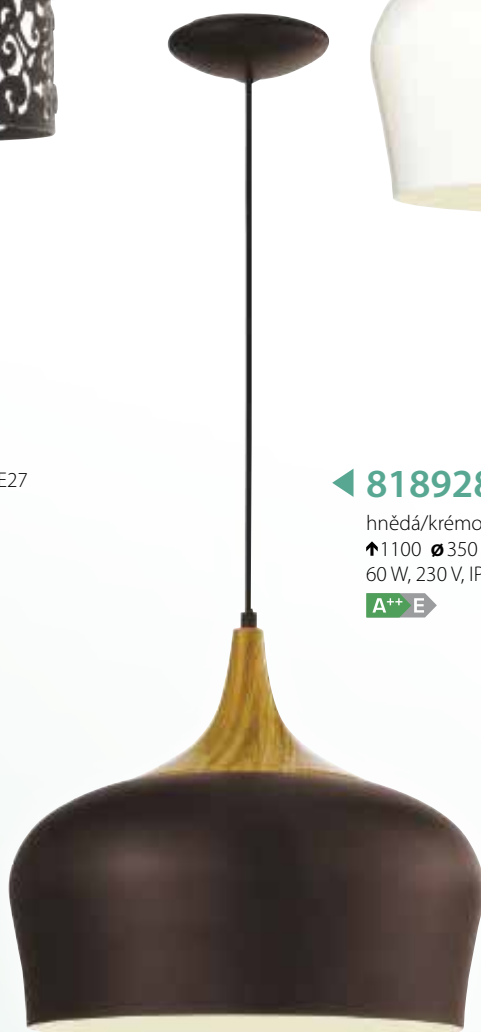

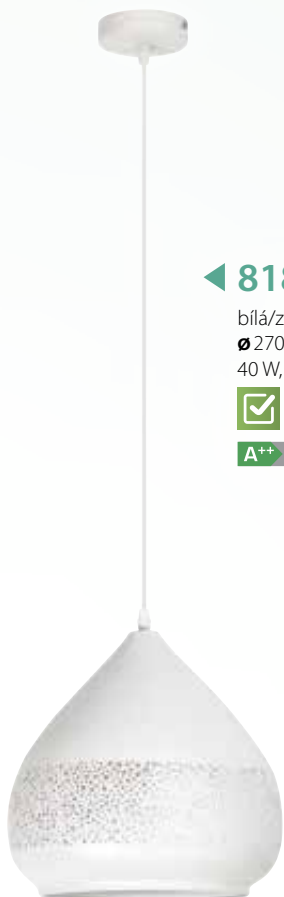

◀ 81892843

bílá/zlatá, kov
 Ø 270
 40 W, 230 V, IP20, E14



A++ E

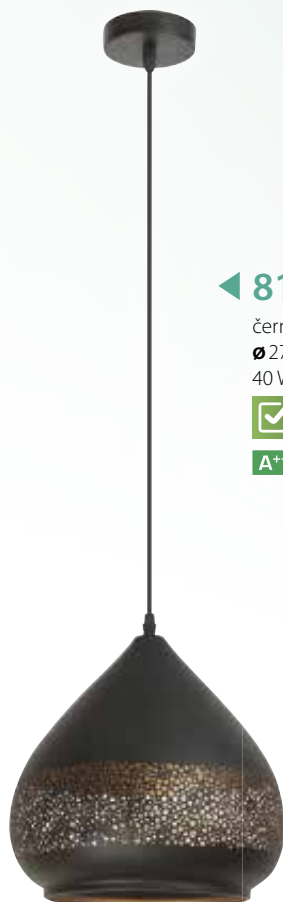

◀ 81892836

černá/zlatá, kov
 Ø 270
 40 W, 230 V, IP20, E14



A++ E



▲ 43995028

bílá, sklo/plast
 ↑ 1200 Ø 400
 60 W, 230 V, IP20, E27



A++ E



▶ 43995027

bílá, sklo/plast
 ↑ 1200 Ø 400
 60 W, 230 V, IP20, E27



A++ E

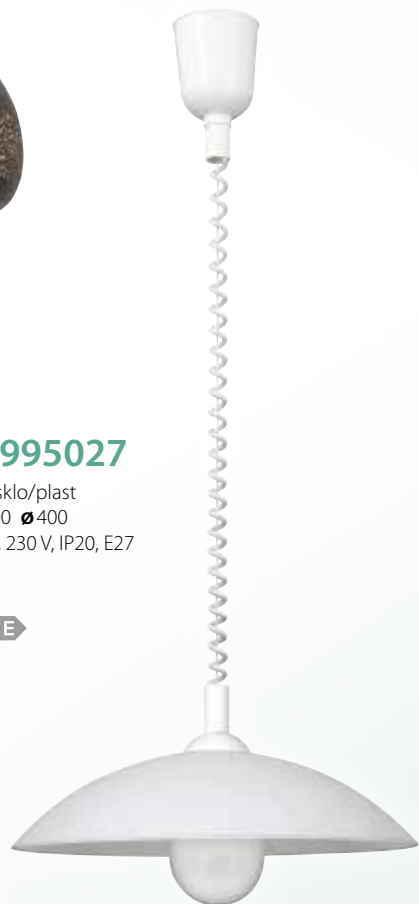

◀ 82384255

černá, kov
 ↑ 1000 Ø 280
 40 W, 230 V, IP20, E27

A++ E

▶ **82599682**

bílá, kov
 ↑25 →600 ↗70
 3× 2,3 W/3 000 K/780 lm, 230 V, IP20, LED
 A+ LED



▲ **81794317**

matný nikl, kov
 ↑25 →600 ↗70
 3× 2,3 W/3 000 K/780 lm, 230 V, IP20, LED
 A+ LED

▼ **82683344**

stříbrná, kov/plast
 ↑58 →620 ↗70
 8 W/4000 K/546 lm, 230 V, IP20, LED

 A+ LED



◀ **82683346**

stříbrná, kov/plast
 ↑58 →445 ↗70
 4 W/4000 K/250 lm, 230 V, IP20, LED
 A+ LED



▶ **81769177**

stříbrná, kov/plast
 ↑22 →610 ↗53
 10 W/3000 K/600 lm, 230 V, IP20, LED

 A LED



◀ **81769176**

stříbrná, kov/plast
 ↑22 →424 ↗53
 7,5 W/3000 K/400 lm, 230 V, IP20, LED

 A LED





◀ 81772708

bílá, sklo/kov
 ↑84 → 355 ↗28
 5,5 W/4100 K/440 lm, 230 V, IP20, LED
A+ LED

▶ 81772710

bílá, sklo/kov
 ↑84 → 584 ↗28
 10 W/4100 K/800 lm, 230 V, IP20, LED
A+ LED



▲ 81772711

bílá, sklo/kov
 ↑84 → 917 ↗28
 15 W/4100 K/1200 lm, 230 V, IP20, LED
A+ LED

▼ 81751005

stříbrná, sklo/kov
 ↑84 → 910 ↗28
 15 W/4100 K/1200 lm, 230 V, IP20, LED
A+ LED

Vše skladem



◀ 81696222

stříbrná, sklo/kov
 ↑84 → 584 ↗28
 10 W/4100 K/800 lm, 230 V, IP20, LED
A+ LED



▶ 81750998

stříbrná, sklo/kov
 ↑84 → 370 ↗28
 5,5 W/4100 K/440 lm, 230 V, IP20, LED
A+ LED







◀ **82683361**

černá/zlatá, kov
 ↑44 Ø98
 35 W, 12 V/230 V, IP20, GX5,3/GU10
 montážní otvor Ø 70 mm

A++ E



▶ **82683362**

bílá/zlatá, kov
 ↑65 Ø68
 35 W, 12 V/230 V, IP20, GX5,3/GU10
 montážní otvor Ø 61–62 mm

A++ E



▲ **82398369**

šedá, beton/kov
 ↑25 →90 ↗90
 35 W, 12 V/230 V, IP20, GX5,3/GU10
 montážní otvor Ø 70 mm

A++ E



▲ **82683360**

bílá/antracit, kov
 ↑44 Ø98
 35 W, 12 V/230 V, IP20, GX5,3/GU10
 montážní otvor Ø 70 mm

A++ E



▶ **82683359**

černá/bílá, kov
 ↑42 →92 ↗92
 35 W, 12 V/230 V, IP20, GX5,3/GU10
 montážní otvor Ø 68 mm

A++ E

▶ **82398497**

černá/zlatá, kov
 ↑42 Ø75
 35 W, 12 V/230 V, IP20, GX5,3/GU10
 montážní otvor Ø 68 mm

A++ E



► **426396**

chrom, kov
 ø 82
 50 W, 12 V, IP20, GX5,3
 montážní otvor ø 60÷70 mm
A++ E



◄ **664755**

bílá, kov
 ø 82
 50 W, 12 V, IP20, GX5,3
 montážní otvor ø 60÷70 mm
A++ E

► **11856**

matná mosaz, kov
 ø 82
 50 W, 12 V, IP20, GX5,3
 montážní otvor ø 60÷70 mm
A++ E



◄ **11858**

matný chrom, kov
 ø 82
 50 W, 12 V, IP20, GX5,3
 montážní otvor ø 60÷70 mm
A++ E



► **232787**

chrom, kov
 ø 97
 50 W, 12 V, IP20, GX5,3
 montážní otvor ø 80÷90 mm
A++ E



Vše skladem



Vše skladem



► **12859**

matný chrom, kov
Ø 97
50 W, 12 V, IP20, GX5,3
montážní otvor Ø 80÷90 mm

A++ E



◄ **584661**

bílá, kov
Ø 97
50 W, 12 V, IP20, GX5,3
montážní otvor Ø 80÷90 mm

A++ E

► **232789**

matná mosaz, kov
Ø 97
50 W, 12 V, IP20, GX5,3
montážní otvor Ø 80÷90 mm

A++ E



◄ **91912**

černý chrom, kov
Ø 97
50 W, 12 V, IP20, GX5,3
montážní otvor Ø 80÷90 mm

A++ E

Vše skladem



▲ **74999581**

matný chrom, kov
 ↑27 →80
 50 W, 230 V, IP20, GU10/GZ10
 montážní otvor ø 60+68 mm

A++ E



▲ **42997338**

chrom, kov
 ↑81 →81
 50 W, 12 V, IP20, GX5,3
 montážní otvor ø 75 mm

A++ E



▲ **34998220**

matný chrom, kov
 ↑81 →81
 50 W, 12 V, IP20, GX5,3 MR-16
 montážní otvor ø 75 mm

A++ E



▲ **35997283**

chrom, kov
 ↑75 →75
 50 W, 12 V, IP20, GX5,3
 montážní otvor ø 60–70 mm

A++ E



▲ **35997282**

matný nikel, kov
 ↑75 →75
 50 W, 12 V, IP20, GX5,3
 montážní otvor ø 60-70 mm

A++ E



▲ **38999242**

bílá, kov
 ↑81 →81
 50 W, 12 V, IP20, GX5,3
 montážní otvor ø 75 mm

A++ E

▶ **80973245**

bílá, kov
 Ø 85
 50 W, 12 V, IP20, GX5,3
 montážní otvor ø 65÷75 mm
A++ E

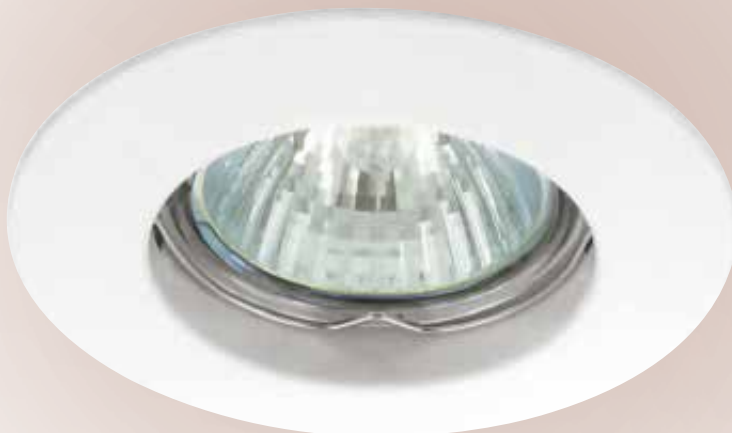

◀ **80967151**

matný chrom, kov
 Ø 85
 50 W, 12 V, IP20, GX5,3
 montážní otvor ø 65÷75 mm
A++ E



Vše skladem



▶ **70995976**

chrom, kov
 Ø 88
 50 W, 12 V, IP20, GX5,3
 montážní otvor ø 75÷80 mm
A++ E



◀ **52998138**

matný chrom, kov
 Ø 88
 50 W, 12 V, IP20, GX5,3
 montážní otvor ø 75÷80 mm
A++ E





◀ **28840**

chrom, kov
 ø 82
 50 W, 12 V, IP20, GX5,3
 montážní otvor ø 75 mm
A++ E

▶ **28839**

matný chrom, kov
 ø 82
 50 W, 12 V, IP20, GX5,3
 montážní otvor ø 75 mm
A++ E



◀ **52994640**

matný nikel, kov
 ø 82
 50 W, 12 V, IP20, GX5,3
 montážní otvor ø 75 mm
A++ E

▶ **60997645**

hliník, kov
 ø 79
 50 W, 12 V, IP20, GX5,3
 montážní otvor ø 70÷75 mm
A++ E



Vše skladem





▲ 70992895

hliník, kov
 ↑24 Ø82
 50 W, 12 V, IP20, GX5,3
 montážní otvor ø 70÷75 mm
 A++ E



▲ 80970026

hliník, kov
 ↑24 →83 ↗83
 50 W, 12 V, IP20, GX5,3
 montážní otvor ø 70÷75 mm
 A++ E



▲ 70999970

hliník, kov
 ↑24 Ø79
 50 W, 12 V, IP20, GX5,3
 montážní otvor ø 60÷70 mm
 A++ E



▲ 70995859

hliník, kov
 ↑24 →79 ↗79
 50 W, 12 V, IP20, GX5,3
 montážní otvor ø 60÷70 mm
 A++ E



▲ 80975774

hliník, kov
 ↑118 Ø82
 50 W, 230 V, IP20, GU10
 montážní otvor ø 70÷75 mm
 A++ E



▲ 80976883

hliník, kov
 ↑118 →82 ↗82
 50 W, 230 V, IP20, GU10
 montážní otvor ø 70÷75 mm
 A++ E

Vše skladem



▲ 80996781

hliník, kov
 ↑118 Ø79
 50 W, 230 V, IP20, GU10
 montážní otvor ø 60÷70 mm
 A++ E



▲ 80964769

hliník, kov
 ↑118 →79 ↗79
 50 W, 230 V, IP20, GU10
 montážní otvor ø 60÷70 mm
 A++ E

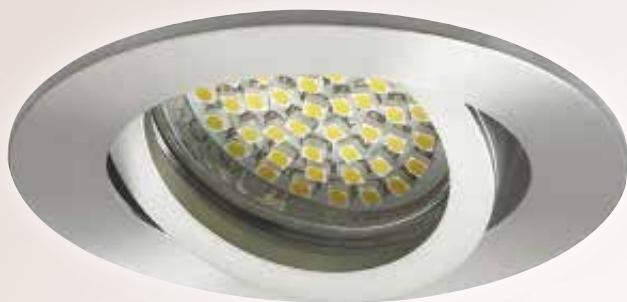

◀ **81268238**

hliník, kov
 ↑29 Ø 82
 50 W, 12 V, IP20, GX5,3
 montážní otvor ø 70-75 mm

A++ E

▶ **81273977**

hliník, kov
 ↑29 →82 ↗82
 50 W, 12 V, IP20, GX5,3
 montážní otvor ø 70-75 mm

A++ E



◀ **80995703**

saténový chrom/nikl, kov
 Ø 82
 50 W, 12 V, IP20, GX5,3
 montážní otvor ø 75 mm

A++ E

▶ **81195638**

kartáčovaný hliník, kov
 ↑29 →90 ↗90
 50 W, 12 V, IP20, GX5,3
 montážní otvor ø 80 mm

A++ E



Vše skladem

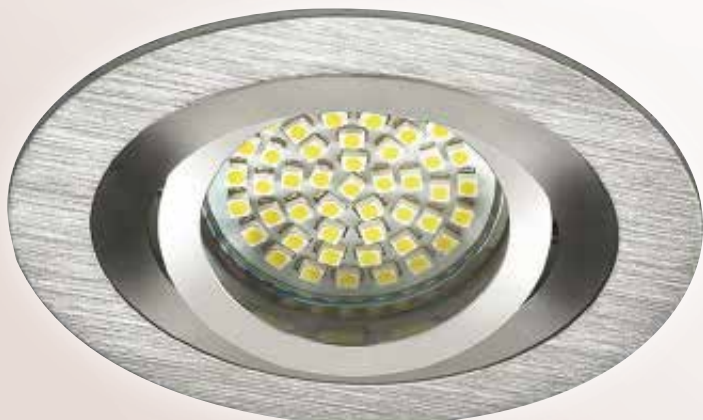

◀ **81199341**

kartáčovaný hliník, kov
 ↑29 Ø 92
 50 W, 12 V, IP20, GX5,3
 montážní otvor ø 80 mm

A++ E



◀ 81293948

černá eloxovaná, kov
 ↑29 Ø82
 50 W, 12 V, IP20, GX5,3
 montážní otvor ø 70–75 mm
 A++ E

▶ 81279685

černá eloxovaná, kov
 ↑29 →82 ↗82
 50 W, 12 V, IP20, GX5,3
 montážní otvor ø 70–75 mm
 A++ E



◀ 81692297

bílá, kov
 ↑26 Ø82
 50 W, 12 V, IP20, GX5,3
 montážní otvor ø 70 mm
 A++ E

▶ 81596923

bílá, kov
 ↑26 →82 ↗82
 50 W, 12 V, IP20, GX5,3
 montážní otvor ø 70 mm
 A++ E



Vše skladem



◀ 81273211

hliník, kov
 ↑66 →90 ↗90
 50 W, 230 V, IP20, GU10
 montážní otvor ø 85 mm

A++ E

▶ 81586913

hliník, kov
 ø 92
 50 W, 230 V, P20, GU10
 montážní otvor ø 80 mm

A++ E



◀ 81586914

hliník, kov
 →92 ↗92
 50 W, 230 V, IP20, GU10
 montážní otvor ø 80 mm

A++ E

▶ 81272565

bílá, kov
 →90 ↗90
 50 W, 230 V, IP20, GU10
 montážní otvor ø 84 mm

A++ E



◀ 81272568

bílá, kov
 →92 ↗92
 50 W, 230 V, IP20, GU10
 montážní otvor ø 80 mm

A++ E

▶ 81272566

bílá, kov
 ø 92
 50 W, 230 V, IP20, GU10
 montážní otvor ø 80 mm

A++ E



► **81287988**

hliník, kov
 →85 ↗85
 50 W, 230 V, IP65, GU10
 montážní otvor ø 60 mm



A++ E

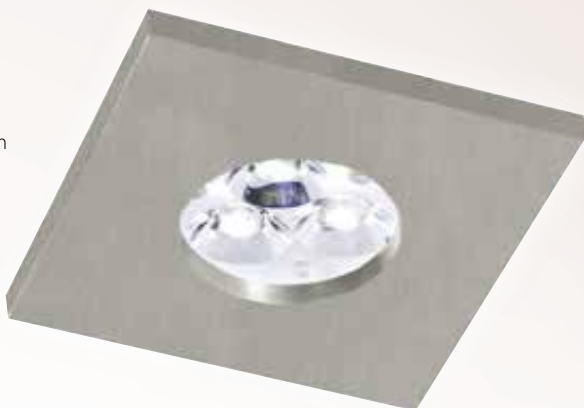

▼ **81267827**

hliník, kov
 ø85
 50 W, 230 V, IP65, GU10
 montážní otvor ø 60 mm



A++ E



▲ **82396096**

černá, kov
 ↑50 →98 ↗98
 35 W, 12 V/230 V, IP20, GX5,3/GU10
 montážní otvor ø 85 mm

A++ E



▲ **82394851**

bílá, kov
 ↑50 ø98
 35 W, 12 V/230 V, IP20, GX5,3/GU10
 montážní otvor ø 85 mm

A++ E

▲ **81590908**

bílá, kov
 ø85
 50 W, 230 V, IP65, GU10
 montážní otvor ø 60 mm



A++ E



◀ **81491539**

bílá, kov
 →85 ↗85
 50 W, 230 V, IP65, GU10
 montážní otvor ø 60 mm

A++ E

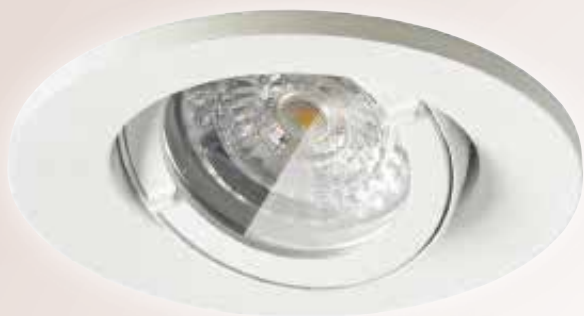

▲ **81753125**

bílá, kov
 ↑100 Ø 95
 5 W/3000 K/425 lm, 230 V, IP44, LED
 montážní otvor ø 75 mm
A+ LED

▼ **81753126**

bílá, kov
 ↑100 Ø 95
 5 W/4000 K/450 lm, 230 V, IP44, LED
 montážní otvor ø 75 mm
A+ LED



▼ **82394964**

bílá, kov
 ↑60 Ø 80
 10 W, 12 V/230 V, IP20, GX5,3/GU10
 montážní otvor ø 67 mm
A++ E



◀ **81765015**

bílá, kov
 ↑47 Ø 90
 8 W/4000 K/720 lm, 230 V, IP20, LED
 montážní otvor ø 83 mm
A+ LED



▲ **38999072**

chrom, kov
 ↑36 Ø 85
 35 W, 12 V, IP44/20, GX5,3
 montážní otvor ø 65÷75 mm
A++ E



▲ **50996805**

matný nikl, kov
 ↑36 Ø 85
 35 W, 12 V, IP44/20, GX5,3
 montážní otvor ø 65÷75 mm
A++ E

Vše skladem





◀ **81798659**

bílá, kov
 ↑44 Ø83
 35 W, 230 V, IP44/20, GU10
 montážní otvor ø 71÷74 mm
A++ E

▼ **81883166**

matný chrom, kov
 ↑44 Ø83
 35 W, 230 V, IP44/20, GU10
 montážní otvor ø 71÷74 mm
A++ E



▲ **81798662**

chrom, kov
 ↑44 Ø83
 35 W, 230 V, IP44/20, GU10
 montážní otvor ø 71÷74 mm
A++ E



▲ **81878962**

bílá, kov
 ↑44 →83 ↗83
 35 W, 230 V, IP44/20, GU10
 montážní otvor ø 71÷74 mm
A++ E

Vše skladem



▲ **81878959**

matný chrom, kov
 ↑44 →83 ↗83
 35 W, 230 V, IP44/20, GU10
 montážní otvor ø 71÷74 mm
A++ E

▶ **81878960**

chrom, kov
 ↑44 →83 ↗83
 35 W, 230 V, IP44/20, GU10
 montážní otvor ø 71÷74 mm
A++ E



► **81789023**

bílá, plast
 ↑55 Ø83
 4,5 W/3000 K/340 lm, 230 V, IP44, LED
 montážní otvor ø 65 mm

A++ A LED



◄ **81789025**

saténový nikl, plast
 ↑55 Ø83
 4,5 W/4000 K/340 lm, 230 V, IP44, LED
 montážní otvor ø 65 mm

A++ A LED



Vše skladem



► **81789026**

bílá, plast
 ↑55 Ø83
 4,5 W/3000 K/370 lm, 230 V, IP44, LED
 montážní otvor ø 65 mm

A++ A LED



◄ **81789028**

saténový nikl, plast
 ↑55 Ø83
 4,5 W/4000 K/370 lm, 230 V, IP44, LED
 montážní otvor ø 65 mm

A++ A LED



▼ **82394990**

bílá, plast/PMMA
 ↑23 →79 ↗76
 6 W/3000 K/380 lm, 230 V, IP65/20, LED
 montážní otvor 60 × 60 mm
A++ A LED



▼ **82395003**

bílá, plast/PMMA
 ↑23 →125 ↗125
 10 W/4000 K/830 lm, 230 V, IP65/20, LED
 montážní otvor 119 × 119 mm
A++ A LED

◀ **82395016**

bílá, plast/PMMA
 ↑23 →156 ↗156
 14 W/3000 K/1100 lm, 230 V, IP65/20, LED
 montážní otvor 140 × 140 mm
A++ A LED

◀ **82395021**

bílá, plast/PMMA
 ↑23 →186 ↗186
 20 W/4000 K/1710 lm, 230 V, IP65/20, LED
 montážní otvor 170 × 170 mm
A++ A LED

Vše skladem



▶ **82394976**

bílá, plast/PMMA
 ↑23 ø75
 6 W/4000 K/410 lm, 230 V, IP65/20, LED
 montážní otvor ø 60 mm
A++ A LED



▶ **82395000**

bílá, plast/PMMA
 ↑23 ø126
 10 W/3000 K/790 lm, 230 V, IP65/20, LED
 montážní otvor ø 119 mm
A++ A LED

▲ **82395009**

bílá, plast/PMMA
 ↑23 ø156
 14 W/4000 K/1150 lm, 230 V, IP65/20, LED
 montážní otvor ø 140 mm
A++ A LED

▲ **82395020**

bílá, plast/PMMA
 ↑23 ø186
 20 W/3000 K/1650 lm, 230 V, IP65/20, LED
 montážní otvor ø 170 mm
A++ A LED

▶ **81287349**

stříbrná, sklo/kov
 ↑28 →90 ↗90
 50 W, 12 V, IP20, GX5,3
 montážní otvor ø 65÷70 mm



◀ **81690070**

stříbrná, sklo/kov
 ↑36 ø 90
 50 W, 12 V, IP20, GX5,3
 montážní otvor ø 65÷70 mm



▶ **81690069**

černá, sklo/kov
 ↑36 ø 90
 50 W, 12 V, IP20, GX5,3
 montážní otvor ø 65÷70 mm



◀ **81690068**

černá, sklo/kov
 ↑36 →90 ↗90
 50 W, 12 V, IP20, GX5,3
 montážní otvor ø 65÷70 mm



▶ **81686428**

stříbrná, sklo/kov
 ↑36 →90 ↗90
 50 W, 12 V, IP20, GX5,3
 montážní otvor ø 65÷70 mm



► **81892578**

matná černá, kov
 ↑130 Ø82
 6 W, 230 V, IP20, GU10
 montážní otvor ø 76 mm



◄ **81892581**

matná bílá, kov
 ↑130 Ø82
 6 W, 230 V, IP20, GU10
 montážní otvor ø 76 mm



► **81892579**

matná černá, kov
 ↑110 Ø85
 6 W, 230 V, IP20, GU10
 montážní otvor ø 76 mm



◄ **81892582**

matná bílá, kov
 ↑110 Ø85
 6 W, 230 V, IP20, GU10
 montážní otvor ø 76 mm



► **81892580**

matná bílá, kov
 ↑110 →85 ↗85
 6 W, 230 V, IP20, GU10
 montážní otvor ø 76 mm





◀ 81589863

bílá, kov/plast
 ↑30 Ø85
 2,7 W/4000 K/360 lm, 230 V, IP20, LED
 montážní otvor Ø 73 mm

A++ LED

◀ 81680151

bílá, kov/plast
 ↑30 Ø85
 2,7 W/3000 K/300 lm, 230 V, IP20, LED
 montážní otvor Ø 73 mm

A++ LED

▶ 81589864

bílá, kov/plast
 ↑30 →85 ↗85
 2,7 W/4000 K/360 lm, 230 V, IP20, LED
 montážní otvor 75 × 75 mm

A++ LED

▶ 81688093

bílá, kov/plast
 ↑30 →85 ↗85
 2,7 W/3000 K/300 lm, 230 V, IP20, LED
 montážní otvor 75 × 75 mm

A++ LED



◀ 81589865

bílá, kov/plast
 ↑30 Ø120
 5,5 W/4000 K/700 lm, 230 V, IP20, LED
 montážní otvor Ø 108 mm

A++ LED

◀ 81594183

bílá, kov/plast
 ↑30 Ø120
 5,5 W/3000 K/600 lm, 230 V, IP20, LED
 montážní otvor Ø 108 mm

A++ LED

▶ 81589866

bílá, kov/plast
 ↑30 →120 ↗120
 5,5 W/4000 K/700 lm, 230 V, IP20, LED
 montážní otvor 105 × 105 mm

A++ LED

▶ 81595525

bílá, kov/plast
 ↑30 →120 ↗120
 5,5 W/3000 K/600 lm, 230 V, IP20, LED
 montážní otvor 105 × 105 mm

A++ LED



◀ 81589867

bílá, kov/plast
 ↑30 Ø170
 10,9 W/4000 K/1350 lm, 230 V, IP20, LED
 montážní otvor Ø 155 mm

A++ LED

◀ 81594184

bílá, kov/plast
 ↑30 Ø170
 10,9 W/3000 K/1200 lm, 230 V, IP20, LED
 montážní otvor Ø 155 mm

A++ LED



Vše skladem





◀ **81595526**

bílá, kov/plast
 ↑30 →170 ↗170
 10,9 W/3000 K/1200 lm, 230 V, IP20, LED
 montážní otvor 155 × 155 mm



A++ LED

◀ **81589869**

bílá, kov/plast
 ↑30 →170 ↗170
 10,9 W/4000 K/1350 lm, 230 V, IP20, LED
 montážní otvor 155 × 155 mm



A++ LED

▲ **81595527**

bílá, kov/plast
 ↑30 →225 ↗225
 16,5 W/3000 K/1700 lm, 230 V, IP20, LED
 montážní otvor 205 × 205 mm



A++ LED

▲ **81589871**

bílá, kov/plast
 ↑30 →225 ↗225
 18 W/4000 K/2080 lm, 230 V, IP20, LED
 montážní otvor 205 × 205 mm



A++ LED

▼ **81891529**

bílá, kov/plast
 ↑30 ø 85
 2,7 W/3000 K/300 lm, 230 V, IP44, LED
 montážní otvor ø 74 mm



A++ LED

▼ **82388671**

bílá, kov/plast
 ↑30 ø 85
 2,7 W/4000 K/360 lm, 230 V, IP44, LED
 montážní otvor ø 74 mm

A++ LED

▶ **81690924**

bílá, kov/plast
 ↑30 ø 225
 16,5 W/3000 K/1600 lm, 230 V, IP20, LED
 montážní otvor ø 207 mm



A++ LED



▶ **81589870**

bílá, kov/plast
 ↑30 ø 225
 18 W/4000 K/2080 lm, 230 V, IP20, LED
 montážní otvor ø 207 mm



A++ LED

▲ **81890477**

bílá, kov/plast
 ↑30 ø 170
 10,9 W/4000 K/1350 lm, 230 V, IP44, LED
 montážní otvor ø 155 mm



A++ LED

▶ **81798679**

bílá, kov/plast
 ↑30 ø 170
 10,9 W/3000 K/1200 lm, 230 V, IP44, LED
 montážní otvor ø 155 mm



A++ LED

▼ 81695619

matný nikl, kov/plast
 ↑30 →225 ↗225
 16,5 W/3000 K/1700 lm, 230 V, IP20, LED
 montážní otvor 205 × 205 mm

A++ LED

▼ 81698222

matný nikl, kov/plast
 ↑30 →170 ↗170
 10,9 W/3000 K/1200 lm, 230 V, IP20, LED
 montážní otvor 155 × 155 mm

A++ LED



▼ 81749608

matný nikl, kov/plast
 ↑30 →120 ↗120
 5,5 W/3000 K/600 lm, 230 V, IP20, LED
 montážní otvor 105 × 105 mm

A++ LED

▲ 81754046

matný nikl, kov/plast
 ↑30 ø 225
 16,5 W/3000 K/1600 lm, 230 V, IP20, LED
 montážní otvor ø 207 mm

A++ LED



▲ 81748983

matný nikl, kov/plast
 ↑30 ø 170
 10,9 W/3000 K/1200 lm, 230 V, IP20, LED
 montážní otvor ø 155 mm

A++ LED

▲ 81695832

matný nikl, kov/plast
 ↑30 ø 120
 5,5 W/3000 K/600 lm, 230 V, IP20, LED
 montážní otvor ø 108 mm

A++ LED

Vše skladem



▶ 81770746

chrom, kov/plast
 ↑30 ø 85
 2,7 W/3000 K/300 lm, 230 V, IP44, LED
 montážní otvor ø 74 mm

A+ LED

▲ 81881969

chrom, kov/plast
 ↑30 ø 170
 10,9 W/3000 K/1200 lm, 230 V, IP44, LED
 montážní otvor ø 155 mm

A+ LED

◀ 81770747

chrom, kov/plast
 ↑30 ø 85
 2,7 W/4000 K/360 lm, 230 V, IP44, LED
 montážní otvor ø 74 mm

A+ LED

Série FUEVA



Série SABIK





◀ 82685186

černá, kov/plast
 ↗ 70
 0,8 W/3000 K/13 lm, 12 V, IP20, LED
 montáž do elektroinstalační krabice ø 60 mm

A++ A LED

◀ 82685187

černá, kov/plast
 ↗ 70
 0,8 W/4000 K/14 lm, 12 V, IP20, LED
 montáž do elektroinstalační krabice ø 60 mm

A++ A LED

▶ 82685190

černá, kov/plast
 ↑ 75 → 75 ↗
 0,8 W/3000 K/13 lm, 12 V, IP20, LED
 montáž do elektroinstalační krabice ø 60 mm

A++ A LED

▶ 82685188

černá, kov/plast
 ↑ 75 → 75 ↗
 0,8 W/4000 K/14 lm, 12 V, IP20, LED
 montáž do elektroinstalační krabice ø 60 mm

A++ A LED



◀ 82683044

černá, kov/plast
 ↑ 75 → 75 ↗
 0,8 W/4000 K/14 lm, 12 V, IP20, LED
 montáž do elektroinstalační krabice ø 60 mm

A++ A LED

◀ 82685191

černá, kov/plast
 ↑ 75 → 75 ↗
 0,8 W/3000 K/13 lm, 12 V, IP20, LED
 montáž do elektroinstalační krabice ø 60 mm

A++ A LED



◀ **81691688**

nerezová ocel, kov/plast
 ↗ 70
 0,8 W/3000 K/13 lm, 12 V, IP20, LED
 montáž do elektroinstalační krabice ø 60 mm
A++ A LED

◀ **81691689**

nerezová ocel, kov/plast
 ↗ 70
 0,8 W/6500 K/15 lm, 12 V, IP20, LED
 montáž do elektroinstalační krabice ø 60 mm

A++ A LED

▶ **81893025**

bílá, kov/plast
 ↑75 →75 ↗7
 0,8 W/3000 K/13 lm, 12 V, IP20, LED
 montáž do elektroinstalační krabice ø 60 mm
A++ A LED

▶ **81893024**

bílá, kov/plast
 ↑75 →75 ↗7
 0,8 W/6500 K/15 lm, 12 V, IP20, LED
 montáž do elektroinstalační krabice ø 60 mm
A++ A LED



◀ **81692273**

nerezová ocel, kov/plast
 ↑75 →75 ↗7
 0,8 W/6500 K/15 lm, 12 V, IP20, LED
 montáž do elektroinstalační krabice ø 60 mm

A++ A LED



◀ **81692272**

nerezová ocel, kov/plast
 ↑75 →75 ↗7
 0,8 W/3000 K/13 lm, 12 V, IP20, LED
 montáž do elektroinstalační krabice ø 60 mm

A++ A LED

► **82094098**

nerezová ocel, kov/plast
 ↑75 →75 ↗7
 0,8 W/6500 K/15 lm, 12 V, IP20, LED
 montáž do elektroinstalační krabice ø 60 mm



A++ A LED



► **82383506**

nerezová ocel, kov/plast
 ↑75 →75 ↗7
 0,8 W/3000 K/13 lm, 12 V, IP20, LED
 montáž do elektroinstalační krabice ø 60 mm



A++ A LED



◄ **81692275**

nerezová ocel, kov/plast
 ↑75 →75 ↗7
 0,8 W/3000 K/13 lm, 12 V, IP20, LED
 montáž do elektroinstalační krabice ø 60 mm



A++ A LED

◄ **81692277**

nerezová ocel, kov/plast
 ↑75 →75 ↗7
 0,8 W/6500 K/15 lm, 12 V, IP20, LED
 montáž do elektroinstalační krabice ø 60 mm

A++ A LED

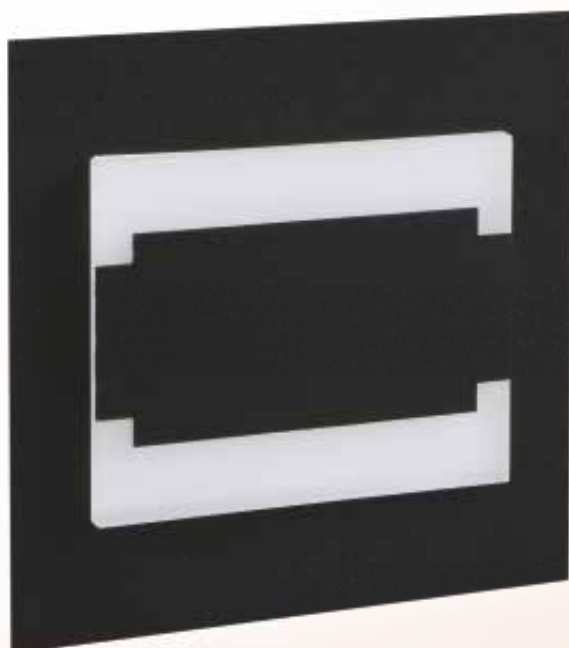

► **82685192**

černá, kov/plast
 ↑75 →75 ↗7
 0,8 W/4000 K/14 lm, 12 V, IP20, LED
 montáž do elektroinstalační krabice ø 60 mm

A++ A LED

► **82685195**

černá, kov/plast
 ↑75 →75 ↗7
 0,8 W/3000 K/13 lm, 12 V, IP20, LED
 montáž do elektroinstalační krabice ø 60 mm

A++ A LED



◀ **81893027**

bílá, kov/plast
 ↑75 →75 ↗7
 0,8 W/3000 K/13 lm, 12 V, IP20, LED
 montáž do elektroinstalační krabice ø 60 mm
A++ A LED

◀ **81893026**

bílá, kov/plast
 ↑75 →75 ↗7
 0,8 W/6500 K/15 lm, 12 V, IP20, LED
 montáž do elektroinstalační krabice ø 60 mm
A++ A LED

▶ **81692270**

nerezová ocel, kov/plast
 ↑75 →75 ↗7
 0,8 W/6500 K/15 lm, 12 V, IP20, LED
 montáž do elektroinstalační krabice ø 60 mm
A++ A LED

▶ **81692268**

nerezová ocel, kov/plast
 ↑75 →75 ↗7
 0,8 W/3000 K/13 lm, 12 V, IP20, LED
 montáž do elektroinstalační krabice ø 60 mm



A++ A LED



◀ **81892996**

nerezová ocel, kov/plast
 ↑75 →75 ↗7
 0,8 W/3000 K/13 lm, 12 V, IP20, LED
 montáž do elektroinstalační krabice ø 60 mm



A++ A LED

◀ **82685198**

nerezová ocel, kov/plast
 ↑75 →75 ↗7
 0,8 W/6500 K/15 lm, 12 V, IP20, LED
 montáž do elektroinstalační krabice ø 60 mm



A++ A LED

◀ **81692274**

nerezová ocel, kov/plast
 ↑75 →75 ↗7
 0,8 W/3000 K/13 lm, 12 V, IP20, LED
 montáž do elektroinstalační krabice ø 60 mm



A++ A LED

◀ **81692276**

nerezová ocel, kov/plast
 ↑75 →75 ↗7
 0,8 W/6500 K/15 lm, 12 V, IP20, LED
 montáž do elektroinstalační krabice ø 60 mm



A++ A LED

▶ **82685202**

nerezová ocel, kov/plast
 ↑75 →75 ↗7
 0,8 W/3000 K/13 lm, 12 V, IP20, LED
 montáž do elektroinstalační krabice ø 60 mm



A++ A LED

▶ **82095097**

nerezová ocel, kov/plast
 ↑75 →75 ↗7
 0,8 W/6500 K/15 lm, 12 V, IP20, LED
 montáž do elektroinstalační krabice ø 60 mm



A++ A LED

◀ **82685204**

černá, kov/plast
 ↑75 →75 ↗7
 0,8 W/4000 K/14 lm, 12 V, IP20, LED
 montáž do elektroinstalační krabice ø 60 mm

A++ A LED

◀ **82398491**

černá, kov/plast
 ↑75 →75 ↗7
 0,8 W/3000 K/13 lm, 12 V, IP20, LED
 montáž do elektroinstalační krabice ø 60 mm

A++ A LED

▶ **82685206**

černá, kov/plast
 ↑75 →75 ↗7
 0,8 W/4000 K/14 lm, 12 V, IP20, LED
 montáž do elektroinstalační krabice ø 60 mm

A++ A LED

▶ **82685209**

černá, kov/plast
 ↑75 →75 ↗7
 0,8 W/3000 K/13 lm, 12 V, IP20, LED
 montáž do elektroinstalační krabice ø 60 mm

A++ A LED

◀ **82496097**

nerezová ocel, kov/plast
 ↑75 →75 ↗7
 0,8 W/4000 K/14 lm, 12 V, IP20, LED
 montáž do elektroinstalační krabice ø 60 mm

A++ A LED

◀ **82685217**

nerezová ocel, kov/plast
 ↑75 →75 ↗7
 0,8 W/3000 K/13 lm, 12 V, IP20, LED
 montáž do elektroinstalační krabice ø 60 mm

A++ A LED

▶ **82685210**

černá, kov/plast
 ↑75 →75 ↗7
 0,8 W/4000 K/14 lm, 12 V, IP20, LED
 montáž do elektroinstalační krabice ø 60 mm

A++ A LED

▶ **82685211**

černá, kov/plast
 ↑75 →75 ↗7
 0,8 W/3000 K/13 lm, 12 V, IP20, LED
 montáž do elektroinstalační krabice ø 60 mm

A++ A LED





◀ 82685219

bílá, plast
 ↑75 →75 ↗7
 0,7 W/3000 K/30 lm, 12 V, IP20, LED
 montáž do elektroinstalační krabice ø 60 mm
A++ A LED

◀ 82685220

bílá, plast
 ↑75 →75 ↗7
 0,7 W/4000 K/35 lm, 12 V, IP20, LED
 montáž do elektroinstalační krabice ø 60 mm
A++ A LED

▶ 82685221

černá, plast
 ↑75 →75 ↗7
 0,7 W/3000 K/30 lm, 12 V, IP20, LED
 montáž do elektroinstalační krabice ø 60 mm
A++ A LED

▶ 82685222

černá, plast
 ↑75 →75 ↗7
 0,7 W/4000 K/35 lm, 12 V, IP20, LED
 montáž do elektroinstalační krabice ø 60 mm
A++ A LED



◀ 82685224

šedá, plast
 ↑75 →75 ↗7
 0,7 W/3000 K/30 lm, 12 V, IP20, LED
 montáž do elektroinstalační krabice ø 60 mm
A++ A LED

◀ 82685225

šedá, plast
 ↑75 →75 ↗7
 0,7 W/4000 K/35 lm, 12 V, IP20, LED
 montáž do elektroinstalační krabice ø 60 mm
A++ A LED

▶ **81598497**

kartáčovaná ocel, kov
 ↑80 →80
 0,42 W/5900 K/23 lm, 14 V, IP44, LED
 montáž do elektroinstalační krabice ø 68 mm



A+ LED

▶ **81598498**

kartáčovaná ocel, kov
 ↑80 →80
 0,56 W/3100 K/15 lm, 14 V, IP44, LED
 montáž do elektroinstalační krabice ø 68 mm



A+ LED



▲ **81285433**

hliník, kov
 ↑73 →73
 0,42 W/5900 K/23 lm, 14 V, IP44, LED
 montáž do elektroinstalační krabice ø 68 mm

A+ LED



◀ **81760178**

kartáčovaná ocel, kov
 ↑80 →80
 1,23 W/5900 K/18 lm, 230 V, IP20, LED
 montáž do elektroinstalační krabice ø 68 mm



A+ LED

▶ **81772689**

kartáčovaná ocel, kov
 ↑73 →73
 0,56 W/3100 K/24 lm, 14 V, IP44, LED
 montáž do elektroinstalační krabice ø 68 mm



A+ LED

▶ **81772688**

kartáčovaná ocel, kov
 ↑73 →73
 0,42 W/5900 K/37 lm, 14 V, IP44, LED
 montáž do elektroinstalační krabice ø 68 mm



A+ LED

▶ **81760179**

kartáčovaná ocel, kov
 ↑73 →73
 0,93 W/5900 K/19 lm, 230 V, IP20, LED
 montáž do elektroinstalační krabice ø 68 mm

A+ LED



◀ **81772700**

kartáčovaná ocel, kov
 ↑73 →73
 0,56 W/3100 K/24 lm, 14 V, IP56, LED
 montáž do elektroinstalační krabice ø 68 mm

A+ LED

◀ **81698840**

kartáčovaná ocel, kov
 ↑73 →73
 0,42 W/5900 K/37 lm, 14 V, IP56, LED
 montáž do elektroinstalační krabice ø 68 mm

A+ LED

▲ **81768437**

kartáčovaná ocel, kov
 ↑80 →80
 0,93 W/3100 K/24 lm, 230 V, IP20, LED
 montáž do elektroinstalační krabice ø 68 mm



A+ LED

▲ **81758000**

kartáčovaná ocel, kov
 ↑80 →80
 1,1 W/5900 K/37 lm, 230 V, IP20, LED
 montáž do elektroinstalační krabice ø 68 mm

A+ LED

▶ **81781687**

kartáčovaná ocel, kov
 ↑80 →80
 1,23 W/5900 K/37 lm, 230 V, IP20, LED
 montáž do elektroinstalační krabice ø 68 mm



A+ LED



Vše skladem



◀ 81772582

stříbrná, plast
 ↑80 →80
 1,1 W/3100 K/16 lm, 230 V, IP20, LED
 montáž do elektroinstalační krabice ø 68 mm
A+ LED

◀ 81772581

stříbrná, plast
 ↑80 →80
 0,93 W/5900 K/19 lm, 230 V, IP20, LED
 montáž do elektroinstalační krabice ø 68 mm
A+ LED

▶ 81772580

bílá, plast
 ↑80 →80
 1,1 W/3100 K/16 lm, 230 V, IP20, LED
 montáž do elektroinstalační krabice ø 68 mm
A+ LED

▶ 81772579

bílá, plast
 ↑80 →80
 0,93 W/5900 K/22 lm, 230 V, IP20, LED
 montáž do elektroinstalační krabice ø 68 mm
A+ LED



◀ 81772590

stříbrná, plast
 ↑80 →80
 1,1 W/3100 K/16 lm, 230 V, IP20, LED
 montáž do elektroinstalační krabice ø 68 mm
A+ LED

◀ 81772589

stříbrná, plast
 ↑80 →80
 0,93 W/5900 K/19 lm, 230 V, IP20, LED
 montáž do elektroinstalační krabice ø 68 mm
A+ LED

▶ 81772588

bílá, plast
 ↑80 →80
 1,1 W/3100 K/16 lm, 230 V, IP20, LED
 montáž do elektroinstalační krabice ø 68 mm
A+ LED

▶ 81772587

bílá, plast
 ↑80 →80
 0,93 W/5900 K/22 lm, 230 V, IP20, LED
 montáž do elektroinstalační krabice ø 68 mm
A+ LED





◀ 81889810

bílá, kov
 ↑80 →80
 0,56 W/3100 K/15 lm, 14 V, IP44, LED
 montáž do elektroinstalační krabice ø 68 mm
 A+ LED

◀ 81889809

bílá, kov
 ↑80 →80
 0,42 W/5900 K/23 lm, 14 V, IP44, LED
 montáž do elektroinstalační krabice ø 68 mm

 A+ LED

◀ 81889811

bílá, kov
 ↑80 →80
 1,1 W/5900 K/37 lm, 230 V, IP56, LED
 montáž do elektroinstalační krabice ø 68 mm
 A+ LED

▲ 81889812

bílá, kov
 ↑80 →80
 0,93 W/3100 K/24 lm, 230 V, IP20, LED
 montáž do elektroinstalační krabice ø 68 mm
 A+ LED

▶ 81889807

bílá, kov
 ↑80 →80
 0,56 W/3100 K/15 lm, 14 V, IP44, LED
 montáž do elektroinstalační krabice ø 68 mm

 A+ LED

▶ 81889808

bílá, kov
 ↑80 →80
 0,42 W/5900 K/23 lm, 14 V, IP44, LED
 montáž do elektroinstalační krabice ø 68 mm
 A+ LED





◀ 80992242

ušlechtilá ocel, kov
 ↑73 →73 ↗10
 0,8 W/3800 K/32 lm, 10 V, IP20, LED
 montáž do elektroinstalační krabice ø 60 mm



A++ A LED

◀ 70991357

ušlechtilá ocel, kov
 ↑73 →73 ↗10
 0,8 W/6000 K/33 lm, 10 V, IP20, LED
 montáž do elektroinstalační krabice ø 60 mm



A++ A LED

▶ 81197403

hliník, kov
 ↑73 →73 ↗10
 0,8 W/3800 K/32 lm, 10 V, IP20, LED
 montáž do elektroinstalační krabice ø 60 mm



A++ A LED

▶ 80963946

hliník, kov
 ↑73 →73 ↗10
 0,8 W/6000 K/33 lm, 10 V, IP20, LED
 montáž do elektroinstalační krabice ø 60 mm



A++ A LED



◀ 81195533

ušlechtilá ocel, kov
 ↑60 →60 ↗10
 0,4 W/3800 K/15 lm, 10 V, IP20, LED
 montáž do elektroinstalační krabice ø 50 mm



A++ A LED

◀ 70991353

ušlechtilá ocel, kov
 ↑60 →60 ↗10
 0,4 W/6000 K/15 lm, 10 V, IP20, LED
 montáž do elektroinstalační krabice ø 50 mm



A++ A LED



▶ 80979681

hliník, kov
 ↑60 →60 ↗10
 0,4 W/6000 K/15 lm, 10 V, IP20, LED
 montáž do elektroinstalační krabice ø 50 mm



A++ A LED



◀ 81768299

ušlechtilá ocel, kov
 ↗10 ø73
 0,8 W/3800 K/21 lm, 10 V, IP66, LED
 montáž do elektroinstalační krabice ø 60 mm

A++ A LED



◀ 81755465

stříbrná, plast
 ↑86 →86
 1 W/4000 K/60 lm, 230 V, IP20, LED
 montáž do elektroinstalační krabice ø 68 mm
A++ A LED

▶ 81755467

matný nikl, plast/kov
 ↑86 →86
 1 W/4000 K/60 lm, 230 V, IP20, LED
 montáž do elektroinstalační krabice ø 68 mm
A++ A LED

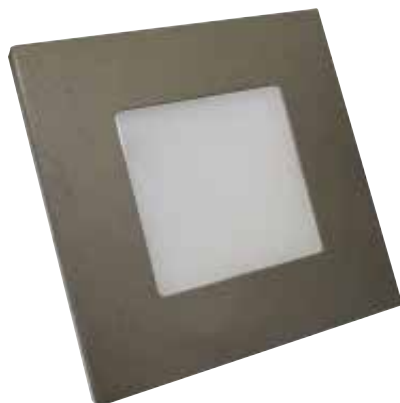

▶ 81755468

nerezová ocel, plast/kov
 ↑86 →86
 1 W/4000 K/60 lm, 230 V, IP20, LED
 montáž do elektroinstalační krabice ø 68 mm
A++ A LED



▲ 81698512

antracit, plast
 ↑86 →86
 1 W/4000 K/60 lm, 230 V, IP20, LED
 montáž do elektroinstalační krabice ø 68 mm
A++ A LED



◀ 81755474

tmavě hnědá, plast
 ↑86 →86
 1 W/4000 K/60 lm, 230 V, IP20, LED
 montáž do elektroinstalační krabice ø 68 mm
A++ A LED



◀ 81755036

světle hnědá, plast
 ↑86 →86
 1 W/4000 K/60 lm, 230 V, IP20, LED
 montáž do elektroinstalační krabice ø 68 mm
A++ A LED

Vše skladem



▶ **80991282**

antracit, sklo/kov

↑350 →200 ↻145

60 W, 230 V, IP44, E27



A++ E





◀ **82685231**

černá, plast
 ↑173 →176 ↗180
 12 W/4000 K/720 lm, 230 V, IP54, LED
 A LED



◀ **82684672**

černá, plast
 ↑173 →176 ↗180
 12 W/4000 K/720 lm, 230 V, IP54, LED
 A LED



◀ **82685229**

antracit, plast/kov
 ↑965 →140 ↗240
 10 W, 230 V, IP44, E27
 A++ E



▶ **82199967**

nerez, plast/kov
 ↑240 →140 ↗185
 10 W, 230 V, IP44, E27
 A++ E



◀ **82685238**

černá, kov
 ↑260 →80 ↗40
 11 W/4000 K/530 lm, 230 V, IP65, LED
 A LED

▶ **82095306**

antracit, plast/kov
 ↑240 →140 ↗185
 10 W, 230 V, IP44, E27
 A++ E



▶ **81887395**

černá, plast
 ↗80 ↻215
 14 W/4000 K/1000 lm, 230 V, IP54, LED



A++ A LED



◀ **81887396**

černá, plast
 ↗80 ↻215
 14 W/4000 K/1000 lm, 230 V, IP54, LED



A++ A LED



▲ **81782788**

šedá, kov
 ↑90 →160 ↗182
 42 W, 230 V, IP44, E27



A++ E

◀ **81782790**

antracit, kov
 ↑90 →160 ↗182
 42 W, 230 V, IP44, E27



A++ E





◀ **81783198**

antická hnědá, sklo/kov
 ↑1080 Ø 225
 60 W, 230 V, IP44, E27



▶ **81771085**

antická hnědá, sklo/kov
 ↑930 Ø 210
 60 W, 230 V, IP44, E27



▲ **81779204**

antická hnědá, sklo/kov
 ↑340 → 215
 60 W, 230 V, IP44, E27



▶ **81783207**

antická hnědá, plast/kov
 ↑270 → 215 → 250
 60 W, 230 V, IP44, E27



▶ **81783208**

antická hnědá, plast/kov
 ↑900 Ø 215
 60 W, 230 V, IP44, E27



◀ **81783209**

antická hnědá, plast/kov
 ↑535 → 330
 60 W, 230 V, IP44, E27

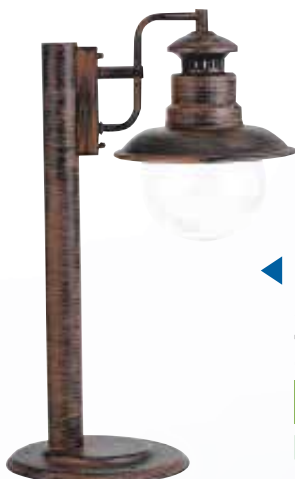

◀ **81783218**

černá, plast/kov
 ↑400 → 300
 60 W, 230 V, IP44, E27



◀ **81783219**

černá, plast/kov
 ↑830 Ø 300
 60 W, 230 V, IP44, E27



▼ **81784505**

antracit, kov
 ↑221 →166 ↗75
 6 W/4000 K/600 lm, 230 V, IP44, LED



A++ LED



◀ **81753995**

antracit, kov
 ↑221 →166 ↗75
 6 W/2700 K/600 lm, 230 V, IP44, LED



A++ LED

◀ **81774481**

antracit, kov
 ↑221 →166 ↗75
 6 W/4000 K/600 lm, 230 V, IP44, LED



A++ LED

◀ **81753997**

antracit, kov
 ↑221 →166 ↗75
 6 W/2700 K/600 lm, 230 V, IP44, LED



A++ LED

▶ **81260895**

antracit, plast/kov
 ↑802 →121 ↗121
 14 W, 230 V, IP44, E27

A++ E



◀ **81753998**

antracit, kov
 ↑400 →100 ↗100
 6 W/2700 K/600 lm, 230 V, IP44, LED

A++ LED



▶ **81261041**

antracit, plast/kov
 ↑245 →118 ↗101
 15 W, 230 V, IP44, E27



A++ E



◀ **81261500**

antracit, plast/kov
 ↑212 →118 ↗101
 15 W, 230 V, IP44, E27



A++ E





◀ **81291046**

antracit, plast/kov
 ↑93 →268 ↗155
 23 W, 230 V, IP44, E27



▶ **81273876**

antracit, plast/kov
 ↑93 →268 ↗155
 23 W, 230 V, IP44, E27

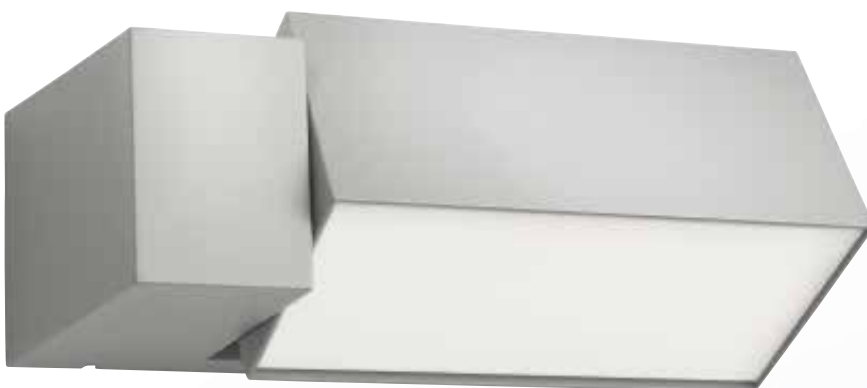

◀ **81285877**

šedá, plast/kov
 ↑93 →268 ↗155
 23 W, 230 V, IP44, E27



▶ **81267276**

šedá, plast/kov
 ↑93 →268 ↗155
 23 W, 230 V, IP44, E27

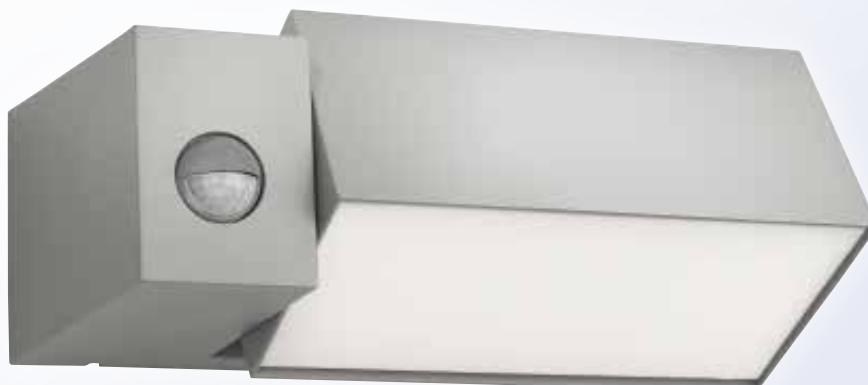



◀ **81784053**

antracit, kov
 ↑92 →220 ↗78
 2x 4,5 W/4000 K/1000 lm, 230 V, IP44, LED

☑
 A++ LED

◀ **81784052**

antracit, kov
 ↑92 →220 ↗78
 2x 4,5 W/2700 K/1000 lm, 230 V, IP44, LED

☑
 A++ LED

▶ **81784143**

antracit, kov
 ↑92 →220 ↗78
 2x 4,5 W/4000 K/1000 lm, 230 V, IP44, LED

☑
 A++ LED

▶ **81784141**

antracit, kov
 ↑92 →220 ↗78
 2x 4,5 W/2700 K/1000 lm, 230 V, IP44, LED

☑
 A++ LED



▶ **81783200**

antracit, kov
 ↑70 →200
 9 W/4000 K/810 lm, 230 V, IP54, LED

A+ LED



◀ **81680040**

antracit, plast/kov
 ↑178 →120 ↗90
 3 W/2700 K/270 lm, 230 V, IP44, LED

A+ LED



▶ **81783199**

antracit, kov
 ↑800 →200
 9 W/4000 K/810 lm, 230 V, IP54, LED

A+ LED

◀ **81680041**

antracit, plast/kov
 ↑763 →166 ↗166
 3 W/2700 K/270 lm, 230 V, IP44, LED

A+ LED

▶ **35999090**

nerez ocel, kov
 ↑230 →70 ↗70
 230 V, IP44

☑



▶ **82398145**

černá, kov
 ↑303 →300 ↗355
 60 W, 230 V, IP44, E27
 A++ E



◀ **82496549**

černá, kov
 ↑218 →300 ↗344
 42 W, 230 V, IP44, E27
 A++ E

▶ **81788198**

černá, kov
 ↑290 →130 ↗175
 42 W, 230 V, IP44, E27
 A++ E



◀ **82384502**

hnědá, kov
 ↑180 →200 ↗200
 42 W, 230 V, IP44, E27
 A++ E



◀ **81280162**

nerezová ocel, plast/kov
 ↑265 →240 ↗280
 60 W, 230 V, IP44, E27



A++ E

▶ **81783217**

nerezová ocel, plast/kov
 ↑760 Ø 240
 60 W, 230 V, IP44, E27



A++ E



▲ **81783216**

nerezová ocel, plast/kov
 ↑215 Ø 240
 60 W, 230 V, IP44, E27



A++ E



▲ **81783212**

antická zlatá, plast/kov
 ↑215 Ø 240
 60 W, 230 V, IP44, E27



A++ E



▲ **81783213**

antická zlatá, plast/kov
 ↑760 Ø 240
 60 W, 230 V, IP44, E27



A++ E

▲ **81285778**

antická zlatá, plast/kov
 ↑265 →240 ↗280
 60 W, 230 V, IP44, E27



A++ E



◀ 81754116

černá, plast/kov
 ↑280 →240 ↗280
 60 W, 230 V, IP44, E27



A++ E

▶ 81783211

černá, plast/kov
 ↑760 Ø 240
 60 W, 230 V, IP44, E27



A++ E



▶ 81783210

černá, plast/kov
 ↑215 Ø 240
 60 W, 230 V, IP44, E27



A++ E



◀ 81783214

bílá, plast/kov
 ↑215 Ø 240
 60 W, 230 V, IP44, E27



A++ E



▲ 81783215

bílá, plast/kov
 ↑760 Ø 240
 60 W, 230 V, IP44, E27



A++ E



▲ 81754117

bílá, plast/kov
 ↑280 →240 ↗280
 60 W, 230 V, IP44, E27



A++ E

◀ 81754118

zelená, plast/kov
 ↑280 →240 ↗280
 60 W, 230 V, IP44, E27



A++ E



▶ **81284932**

nerez, plast/kov
 ↑810 →100 ↗100
 14 W, 230 V, IP44, E27
 A++ E

◀ **81588065**

nerez, sklo/kov
 ↑190 →140 ↗110
 60 W, 230 V, IP44, E27



▲ **70990221**

nerez, sklo/kov
 ↑200 →176 ↗93
 12 W, 230 V, IP44, E14



▲ **52996575**

nerez, sklo/kov
 ↑155 →140 ↗100
 60 W, 230 V, IP44, E27



▶ **70991322**

nerez, sklo/kov
 ↑235 →177 ↗110
 12 W, 230 V, IP44, E14





◀ **81697873**

antracit, plast/kov
 ↑195 →195 ↗135
 12 W, 230 V, IP44, E27



A++ E

▶ **80999094**

antracit, plast/kov
 ↑195 →195 ↗135
 12 W, 230 V, IP44, E27



A++ E



◀ **81752903**

šedá, plast/kov
 ↑195 →195 ↗135
 12 W, 230 V, IP44, E27



A++ E

▶ **80997982**

šedá, plast/kov
 ↑195 →195 ↗135
 12 W, 230 V, IP44, E27



A++ E

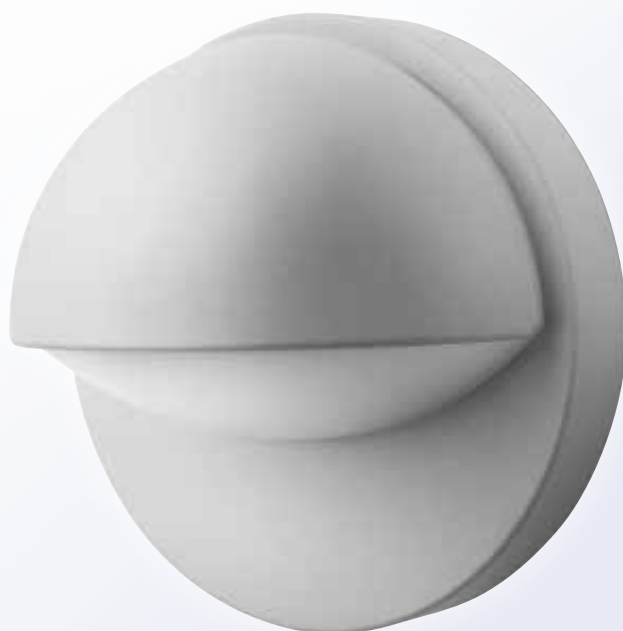

▼ **81292351**

antická zlatá, plast/kov
 ↑100 →318 ↗90
 14 W, 230 V, IP44, E27



A++ E



▲ **81292348**

antracit, plast/kov
 ↑100 →318 ↗90
 14 W, 230 V, IP44, E27



A++ E



◀ **81299278**

nerez, plast/kov
 ↑100 →318 ↗90
 14 W, 230 V, IP44, E27



A++ E

▶ **81753999**

nerez, plast/kov
 ↑162 →230 ↗145,4
 6 W/2700 K/600 lm, 230 V, IP44, LED



A++ LED

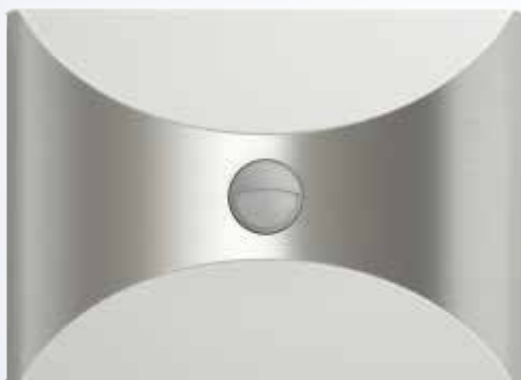
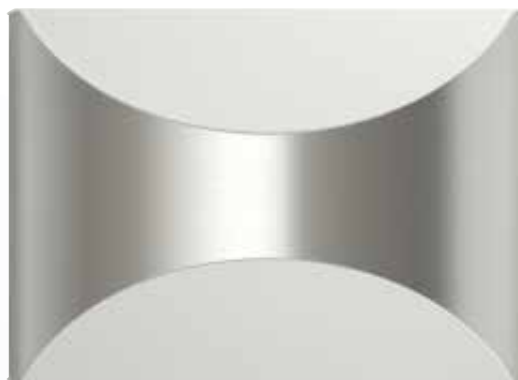

◀ **81754000**

nerez, plast/kov
 ↑162 →230 ↗145,4
 6 W/2700 K/600 lm, 230 V, IP44, LED



A++ LED



◀ **80990951**

nerez, kov
 ↑340 →100
 60 W, 230 V, IP44, E27



A++ E

▶ **80991289**

bílá/nerez, sklo/kov
 ↑260 →235 ↗90
 60 W, 230 V, IP33, E27



A++ E

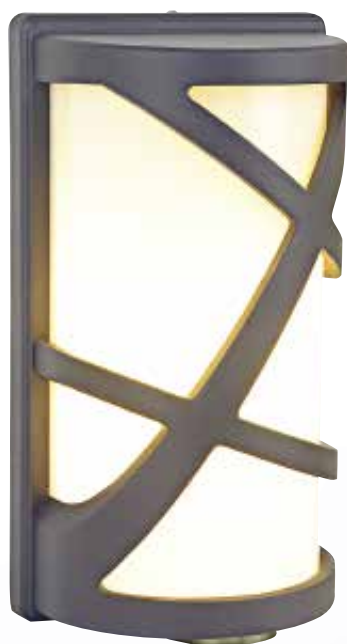

▲ **81783202**

antracit, sklo/kov
 ↑267 →146 ↗98
 40 W, 230 V, IP54, E27



A++ E

▶ **80991288**

bílá/nerez, sklo/kov
 ↑260 →235 ↗90
 60 W, 230 V, IP33, E27



A++ E



◀ **81783201**

hnědá, sklo/kov
 ↑267 →146 ↗98
 40 W, 230 V, IP54, E27



A++ E

▶ **81291487**

šedá, plast/kov
 ↑82 →171 ↗170
 15 W, 230 V, IP44, E27



◀ **81753994**

antracit, kov
 ↑130 →130 ↗127
 2x 4,5 W/2700 K/800lm, 230 V, IP44, LED



▲ **81282116**

antracit, plast/kov
 ↑82 →171 ↗170
 15 W, 230 V, IP44, E27



▶ **82386110**

bílá, kov
 ↑100 →100 ↗100
 7 W/4000 K/500 lm, 230 V, IP54, LED



▼ **82382922**

grafit, kov
 ↑100 →100 ↗100
 7 W/4000 K/360 lm, 230 V, IP54, LED



▲ **82386108**

bílá, kov
 ↑100 →135 ↗115
 7 W/4000 K/510 lm, 230 V, IP54, LED



◀ **82386105**

grafit, kov
 ↑100 →135 ↗115
 7 W/4000 K/380 lm, 230 V, IP54, LED





◀ 81596819

antracit, plast/kov
 ↑260 →260 ↗81
 14 W, 230 V, IP44, E27



▶ 80990589

šedá, plast/kov
 ↑260 →260 ↗81
 14 W, 230 V, IP44, E27



◀ 82096681

antracit, plast/kov
 ↑190 →190 ↗53
 12 W/2 700 K/1200 lm, 230 V, IP44, LED



◀ 82197414

antracit, plast/kov
 ↑190 →190 ↗53
 12 W/4000 K/1200 lm, 230 V, IP44, LED



▶ 82298010

antracit, plast/kov
 ↑190 →190 ↗90
 12 W/4000 K/1200 lm, 230 V, IP44, LED



◀ 82197215

antracit, plast/kov
 ↑190 →190 ↗90
 12 W/2700 K/1200 lm, 230 V, IP44, LED



▶ **81754114**

hliník, kov
 ↑80 →65 ↗94
 35 W, 230 V, IP44, GU10
 A++ E



◀ **82298044**

antracit, kov
 ↑123 →65 ↗100
 10 W, 230 V, IP54, GU10
 A++ E



◀ **81691759**

hnědá patina, kov
 ↑145 →65 ↗94
 2x 35 W, 230 V, IP44, GU10

 A++ E



▶ **82384260**

antracit, kov
 ↑160 →65 ↗100
 2x 10 W, 230 V, IP54, GU10
 A++ E



▶ **81754115**

černá, kov
 ↑80 →65 ↗94
 35 W, 230 V, IP44, GU10
 A++ E



◀ **82384259**

bílá, kov
 ↑123 →65 ↗100
 10 W, 230 V, IP54, GU10
 A++ E



◀ **81681073**

černá, kov
 ↑145 →65 ↗94
 2x 35 W, 230 V, IP44, GU10

 A++ E



▶ **82298045**

bílá, kov
 ↑160 →65 ↗100
 2x 10 W, 230 V, IP54, GU10
 A++ E





▶ **81798724**

bílá, plast/kov
 ↑300 →300 ↗40
 22 W/3000 K/2600 lm, 230 V, IP44, LED



A++ A LED



◀ **81784315**

antracit, plast/kov
 ↑300 →300 ↗40
 22 W/3000 K/2600 lm, 230 V, IP44, LED



A++ A LED



◀ **81692101**

antracit, kov
 ↑200 →65 ↗95
 2x 3 W, 230 V, IP44, GU10

A+



◀ **81757548**

měděná s patinou, plast/kov
 ↑240 Ø220
 40 W, 230 V, IP44, E27

A++ E



◀ **81690667**

antracit, kov
 ↑150 →65 ↗95
 3 W, 230 V, IP44, GU10



A+

▼ **80991282**

antracit, sklo/kov
 ↑350 →200 ↗145
 60 W, 230 V, IP44, E27



A++ E



◀ **81686280**

antracit, plast/kov
 ↑250 →180
 2x 2,5 W/3000 K/360 lm, 230 V, IP44, LED



A+ LED





◀ **82298048**

antracit, plast/kov
 ↑220 → 120 ↗72
 10 W/4000 K/800 lm, 230 V, IP65, LED

A+ LED

▶ **81891874**

antická hnědá, sklo/hliník
 ↑200 → 150
 8,5 W/4000 K/550 lm, 230 V, IP44, LED



A+ LED



▶ **82298051**

antracit, plast/kov
 ↑220 → 120 ↗72
 11 W/3000 K/800 lm, 230 V, IP65, LED



A+ LED



▲ **81891908**

antracitově šedá, hliník/plast
 ↑72 → 230
 10 W/4000 K/1000 lm, 230 V, IP65, LED



A+ LED

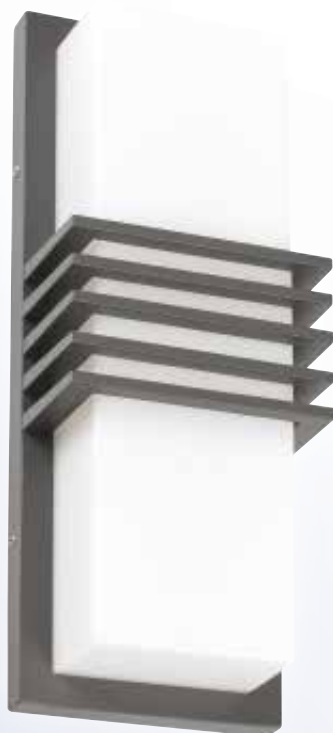

▲ **82298047**

antracit, plast/kov
 ↑300 → 115
 12 W/3000 K/800 lm, 230 V, IP44, LED

A LED

▶ **81891907**

antracitově šedá, hliník/plast
 ↑175 → 106
 11 W/4000 K/1200 lm, 230 V, IP65, LED



A+ LED



◀ **82383494**

antracit, sklo/kov
 ↑170 → 200 ↗66
 9 W/3000 K/680 lm, 230 V, IP54, LED



A+ LED



▶ 81891875

matně černá, nerez/plast
 ↑365 Ø 73
 25 W, 230 V, IP44, E27



A++ E



◀ 81891876

matně černá, nerez/plast
 ↑365 Ø 73
 25 W, 230 V, IP44, E27



A++ E



▶ 81891877

matně černá, nerez/plast
 ↑450 Ø 73
 25 W, 230 V, IP44, E27



A++ E



◀ 81891878

matně černá, nerez/plast
 ↑1100 Ø 73
 25 W, 230 V, IP44, E27



A++ E



◀ **81891909**

šedá, hliník/plast
 ↑250 →250
 20 W/4000 K/2000 lm, 230 V, IP65, LED
A+ LED

▶ **81891910**

antracitově šedá, hliník/plast
 ↑250 →250
 20 W/4000 K/2000 lm, 230 V, IP65, LED
A+ LED

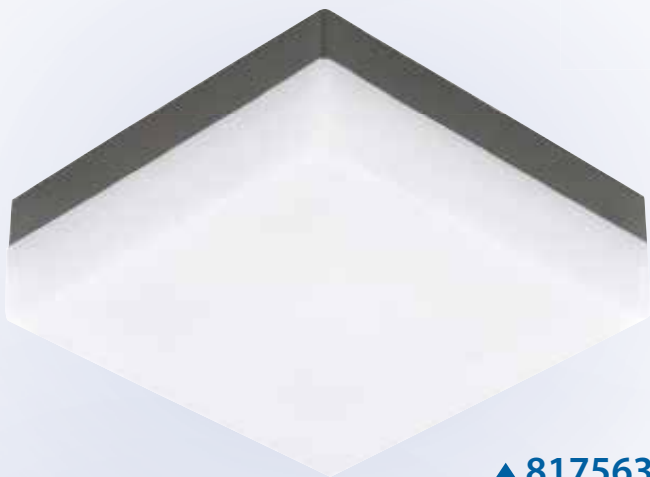

Vše skladem



▲ **81756309**

antracit, plast
 ↑215 →215
 8,2 W/3000 K/820 lm, 230 V, IP44, LED
A+ LED

▲ **81891879**

antracitově šedá, sklo/hliník
 ↑92 →87 ↗87
 35 W, 230 V, IP54, GU10
A++ E

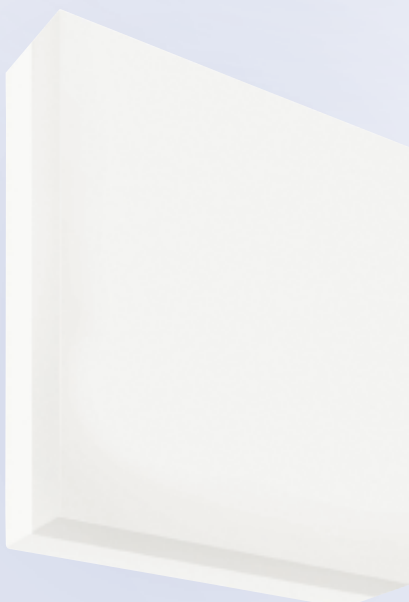

◀ **81756308**

bílá, plast
 ↑215 →215
 8,2 W/3000 K/820 lm, 230 V, IP44, LED
A+ LED

▶ **81891880**

antracitově šedá, sklo/hliník
 ↑92 Ø90
 35 W, 230 V, IP54, GU10
A++ E



▶ **82394974**

bílá, plast/kov
 ↑90 →220 ↗80
 8 W/4000 K/375 lm, 230 V, IP54, LED



A++ A LED



◀ **82394970**

grafit, plast/kov
 ↑90 →220 ↗80
 8 W/4000 K/140 lm, 230 V, IP54, LED



A++ A LED



▶ **81685064**

antracit, kov
 ↑125 →124 ↗28
 1,1 W/6 500 K/30 lm, 230 V, IP65, LED



A++ A LED



▼ **82685245**

bílá, plast
 ↑120 →120 ↗32
 3 W/4000 K/100 lm, 230 V, IP65, LED

A LED



▲ **81685063**

antracit, kov
 ↑78 →230 ↗27
 1,7 W/6 500 K/60 lm, 230 V, IP65, LED



A++ A LED

▶ **82685243**

antracit, plast
 ↑120 →120 ↗32
 3 W/4000 K/100 lm, 230 V, IP65, LED

A LED



▶ **81756284**

antracit, plast/kov
 ↑160 → 160 ↗190
 10 W/3000 K/900 lm, 230 V, IP44, LED
A+ LED



▶ **82397624**

antracit, plast/kov
 ↑800 → 135 ↗75
 6 W/3000 K/600 lm, 230 V, IP44, LED
A++ A LED



◀ **82685227**

bílá, plast/kov
 ↑400 → 135 ↗75
 6 W/3000 K/600 lm, 230 V, IP44, LED
A++ A LED



▶ **82389780**

bílá, plast/kov
 ↑75 → 135 ↗120
 6 W/3000 K/600 lm, 230 V, IP44, LED



A++ A LED



◀ **82385052**

antracit, plast/kov
 ↑75 → 135 ↗120
 6 W/3000 K/600 lm, 230 V, IP44, LED
A++ A LED



▲ **81774311**

žulová, ABS/PE
 ↑280 Ø 300
 25 W, 230 V, IP65, E27
 A++ E



◀ **82096291**

žulová, ABS/PE
 ↑190 Ø 200
 15 W, 230 V, IP65, E27
 A++ E

▼ **82685265**

žulová, ABS/PE
 ↑190 →630 ↗380
 2x 25 W, 230 V, IP65, E27
 A++ E



▲ **81774313**

žulová, ABS/PE
 ↑480 Ø 500
 25 W, 230 V, IP65, E27
 A++ E

Vše skladem



▶ **81774312**

žulová, ABS/PE
 ↑380 Ø 400
 25 W, 230 V, IP65, E27
 A++ E



▼ 82685342

vícebarevná, plast/dřevo

↑1100 →325 ↗105

60 W, 230 V, IP20, E27

A++ E





◀ 82685318

mátová, kov
 ↑100 →75 ↗115
 5 W, 230 V, IP20, GU10
 A++ A



▲ 82685319

mátová, kov
 ↑120 →320
 5 W, 230 V, IP20, GU10
 A++ A

▶ 82685321

mátová, kov
 ↑120 →510
 5 W, 230 V, IP20, GU10
 A++ A



▲ 82685324

červená, kov
 ↑130 Ø 240
 5 W, 230 V, IP20, GU10
 A++ A

▶ 82685320

mátová, kov
 ↑130 Ø 240
 5 W, 230 V, IP20, GU10
 A++ A



▲ 82685325

červená, kov
 ↑120 →510
 5 W, 230 V, IP20, GU10
 A++ A

▼ 82685323

červená, kov
 ↑120 →320
 5 W, 230 V, IP20, GU10
 A++ A



▶ 82685322

červená, kov
 ↑100 →75 ↗115
 5 W, 230 V, IP20, GU10
 A++ A





▲ 82685327

černá/bílá/chrom, kov/sklo
 ↑160
 15 W, 230 V, IP20, G9
 A++



▲ 82685326

černá/bílá, kov/sklo
 Ø 320
 14 W, 230 V, IP20, E27
 A++ E



▲ 82685330

černá/bílá/chrom, kov/sklo
 →600
 4x 15 W, 230 V, IP20, G9
 A++



◀ 82685328

černá/bílá/chrom, kov/sklo
 →255
 2x 15 W, 230 V, IP20, G9
 A++



◀ 60996121

černá/bílá, kov/sklo
 Ø 245
 60 W, 230 V, IP20, E27
 A++ E



▲ 82685329

černá/bílá/chrom, kov/sklo
 →280
 3x 15 W, 230 V, IP20, G9
 A++

▶ **82685352**

vícebarevná, plast
 Ø 100
 0,3 W, 3 V, IP20, LED
A++ A LED



▶ **82685351**

vícebarevná, plast
 Ø 400
 2x 60 W, 230 V, IP20, E27
A++ E



◀ **82286793**

vícebarevná, plast
 Ø 400
 2x 60 W, 230 V, IP20, E27
A++ E

▼ **82685331**

vícebarevná, kov/sklo
 ↑400 →400
 2x 60 W, 230 V, IP20, E27
A++ E



◀ **82196198**

vícebarevná, plast
 Ø 100
 0,3 W, 3 V, IP20, LED
A++ A LED

▶ **82384641**

vícebarevná, plast
 Ø 100
 0,3 W, 3 V, IP20, LED
A++ A LED





▲ 82397256

bílá, kov/plast
 Ø160
 6 W/3000 K/360 lm, 230 V, IP20, LED

A+ LED



▲ 82397254

bílá, kov/plast
 ↑160 →260
 12 W/4000 K/720 lm, 230 V, IP20, LED

A+ LED

Vše skladem



▶ 82393847

bílá, kov/plast
 ↑150 →400
 14 W/4000 K/840 lm, 230 V, IP20, LED

A+ LED



▼ 82397255

bílá, kov/plast
 ↑250 →250
 12 W/4000 K/720 lm, 230 V, IP20, LED

A+ LED



▲ 82386529

bílá, kov/plast
 ↑270 →250
 18 W/4000 K/1080 lm, 230 V, IP20, LED

A+ LED

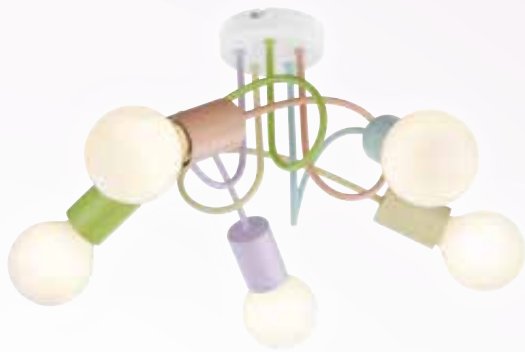

◀ 82685334

vícebarevná, kov
 ↑205 Ø 355
 40 W, 230 V, IP20, E27
 A++ E



▲ 82685332

zelená, plast
 ↑65 →400 ↗400
 36 W/4000 K/3000 lm, 230 V, IP20, LED
 A LED



▲ 82685333

růžová, plast
 ↑65 →400 ↗400
 36 W/4000 K/3000 lm, 230 V, IP20, LED
 A LED

▶ 82398774

modrá/bílá, kov/sklo
 ↑80 Ø 630
 60 W, 230 V, IP20, E27
 A++ E



◀ 81685058

růžová/bílá, kov/sklo
 ↑80 Ø 615
 60 W, 230 V, IP20, E27
 A++ E



▶ **82685340**

vícebarevná, kov/textil
 ↑255 Ø 120
 15 W, 230 V, IP20, E14
 A++ E



◀ **82391687**

vícebarevná, kov/textil
 ↑110 Ø 380
 40 W, 230 V, IP20, E27
 A++ E

◀ **82685342**

vícebarevná, plast/dřevo
 ↑1100 →325 ↗105
 60 W, 230 V, IP20, E27
 A++ E



▲ **82685343**

vícebarevná, kov/dřevo
 ↑75 Ø 400
 3× 40 W, 230 V, IP20, E14
 A++ E



◀ **82685341**

vícebarevná, kov/textil
 ↑255 Ø 120
 15 W, 230 V, IP20, E14
 A++ E



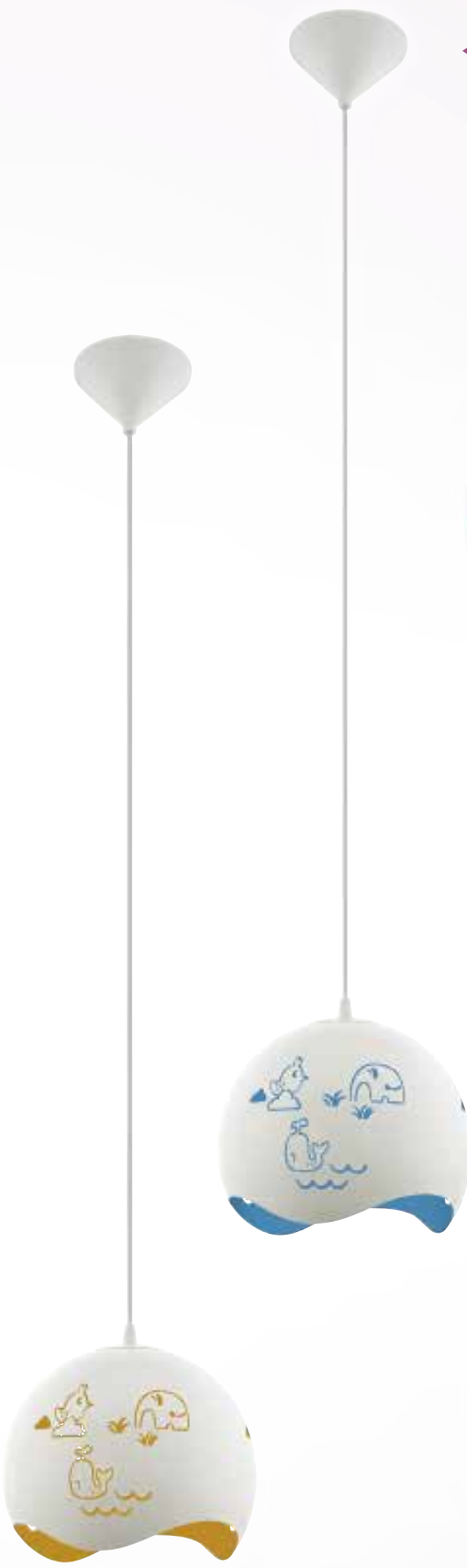

◀ **82685349**

bílá/modrá, kov/plast
 ↑1200 Ø250
 60 W, 230 V, IP20, E27
 A++ E



◀ **80998779**

vícebarevná, kov/sklo
 ↑100 Ø395
 2x 60 W, 230 V, IP20, E27

 A++ E

▶ **60996439**

vícebarevná, kov/sklo
 ↑100 Ø395
 2x 60 W, 230 V, IP20, E27

 A++ E

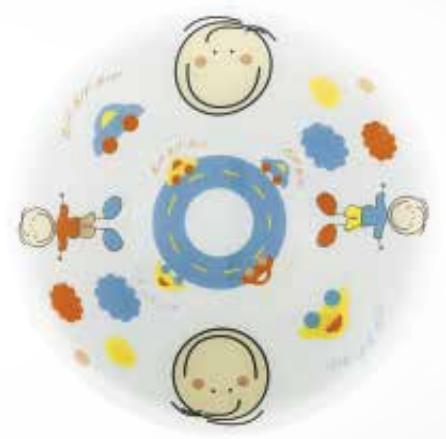

◀ **82293067**

vícebarevná, kov/textil
 ↑110 Ø380
 2x 40 W, 230 V, IP20, E27
 A++ E



▲ **82685350**

bílá/žlutá, kov/plast
 ↑1200 Ø250
 60 W, 230 V, IP20, E27
 A++ E

▶ **82685346**

vícebarevná, kov/textil
 ↑110 Ø380
 2x 40 W, 230 V, IP20, E27
 A++ E





◀ 82685337

vícebarevná, kov
 ↑120 →200
 4x 40 W, 230 V, IP20, E14
 A++ E

▶ 82685335

vícebarevná, kov
 ↑120 →100
 15 W, 230 V, IP20, E14
 A++ E



▶ 82685339

vícebarevná, kov
 ↑1250 Ø 250
 40 W, 230 V, IP20, E27
 A++ E



◀ 82685338

vícebarevná, kov
 →100
 15 W, 230 V, IP20, E14
 A++ E



▲ 82685336

vícebarevná, kov
 ↑120 →300
 2x 40 W, 230 V, IP20, E14
 A++ E

▼ 82398774

modrá/bílá, kov/sklo

↑80 Ø630

60 W, 230 V, IP20, E27

A++ E

DĚTSKÁ, NÁLADOVÁ



Série AREL



▶ **82682440**



bílá, plast
 ↑81 Ø 250
 10 W/2700 K/980 lm, 230 V, IP44, LED



▶ **82399346**



bílá, plast
 ↑81 Ø 250
 10 W/4000 K/1050 lm, 230 V, IP44, LED

◀ **82399348**



bílá, plast
 ↑23 Ø 300
 18 W/2700 K/1500 lm, 230 V, IP20, LED







◀ **82498240**

bílá, plast
 ↑23 Ø 300
 18 W/4000 K/1700 lm, 230 V, IP20, LED



▲ **82497469**

bílá, plast
 ↑23 Ø 250
 15 W/2700 K/1300 lm, 230 V, IP20, LED



▲ **82682436**

bílá, plast
 ↑23 Ø 250
 15 W/4000 K/1500 lm, 230 V, IP20, LED



Vše skladem





▶ **82682437**

bílá, plast
 ↑73 Ø 225
 6 W/4000 K/640 lm, 230 V, IP20, LED



▶ **82399350**

bílá, plast
 ↑73 Ø 250
 10 W/4000 K/1100 lm, 230 V, IP20, LED





▶ **82682438**

bílá, plast
 ↑73 Ø 320
 17 W/4000 K/1900 lm, 230 V, IP20, LED





▲ **81292270**

bílá, sklo/kov
 Ø 400
 2x 60 W, 230 V, IP20, E27

A++ E



▲ **81497846**

bílá, sklo/kov
 Ø 300
 60 W, 230 V, IP20, E27

A++ E

Vše skladem



◀ **38999036**

bílá, sklo/kov
 ↑ 110 Ø 400
 2x 60 W, 230 V, IP20, E27

A++ E



▲ **60998657**

bílá, sklo/kov
 ↑ 90 Ø 300
 60 W, 230 V, IP20, E27

A++ E

▶ **81189571**

hnědá patina, sklo/kov
 Ø 400
 2x 60 W, 230 V, IP20, E27

A++ E



◀ **81189570**

hnědá patina, sklo/kov
 Ø 300
 60 W, 230 V, IP20, E27

A++ E





◀ **81691750**

bílá, sklo/kov
 Ø 400
 2x 60 W, 230 V, IP20, E27
 A++ E

▼ **81691771**

bílá, sklo/kov
 ↑ 150 → 300
 60 W, 230 V, IP20, E27
 A++ E



◀ **81749216**

bílá, sklo/kov
 Ø 300
 60 W, 230 V, IP20, E27
 A++ E

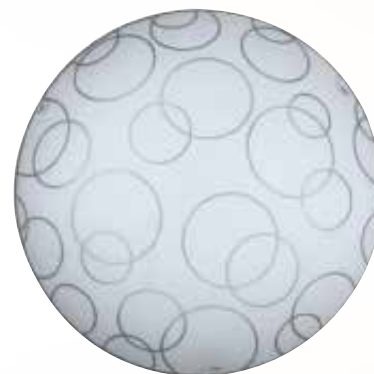

▲ **81694570**

bílá, sklo/kov
 Ø 250
 60 W, 230 V, IP20, E27
 A++ E

Vše skladem



▲ **80990902**

bílá, sklo/kov
 ↑ 390 → 390
 2x 60 W, 230 V, IP20, E27
 A++ E

▶ **80990901**

bílá, sklo/kov
 ↑ 310 → 310
 60 W, 230 V, IP20, E27
 A++ E





◀ 82381296

bílá, kov/plast
 Ø 400
 72 W/3000–6500 K/3900 lm, 230 V, IP20, LED



A+ LED

▶ 82685249

leštěný hliník/bílá, kov/plast
 Ø 380
 24 W/3000 K/1290 lm, 230 V, IP20, LED

A+ LED



◀ 82384250

leštěný hliník/bílá, kov/plast
 Ø 500
 36 W/3000 K/1940 lm, 230 V, IP20, LED

A+ LED

▶ 82384249

bílá, kov/plast
 Ø 340
 16 W/3000–6500 K/1200 lm, 230 V, IP20, LED



A+ LED



◀ 82393811

bílá, kov/plast
 → 340 ↗ 340
 16 W/3000–6500 K/1200 lm, 230 V, IP20, LED



A+ LED



◀ **81274041**

bílá/tmavě hnědá, dřevo/sklo
 Ø 300
 60 W, 230 V, IP20, E27



A++ E

▶ **81198319**

bílá/tmavě hnědá, dřevo/sklo
 Ø 380
 2x 60 W, 230 V, IP20, E27



A++ E



◀ **81296514**

bílá/hnědá, dřevo/sklo
 Ø 300
 60 W, 230 V, IP20, E27



A++ E

▶ **81198317**

bílá/hnědá, dřevo/sklo
 Ø 380
 2x 60 W, 230 V, IP20, E27



A++ E



▼ **81275032**

bílá/matný nikl, sklo/kov
 Ø 310
 60 W, 230 V, IP20, E27



A++ E



▶ **81195570**

bílá/nerez, sklo/kov
 Ø 285
 60 W, 230 V, IP20, E27



A++ E



▶ **81199738**

bílá/matný nikl, sklo/kov
 Ø 380
 2x 60 W, 230 V, IP20, E27



A++ E



▼ **81195573**

bílá, sklo/kov
 Ø 310
 60 W, 230 V, IP20, E27



A++ E



▶ **81198316**

bílá, sklo/kov
 Ø 380
 60 W, 230 V, IP20, E27



A++ E



Vše skladem



▶ **80990903**

bílá/chrom, sklo/kov
↑110 Ø230
60 W, 230 V, IP20, E27
A++ E



◀ **80998633**

bílá/matný chrom, sklo/kov
↑110 Ø230
60 W, 230 V, IP20, E27
A++ E

▶ **80977068**

bílá/chrom, sklo/kov
↑120 Ø280
2x 60 W, 230 V, IP20, E27
A++ E



◀ **80998632**

bílá/matný chrom, sklo/kov
↑120 Ø280
2x 60 W, 230 V, IP20, E27
A++ E

▶ **82286703**

bílá, plast
 ↑90 Ø260
 12 W/4000 K/800 lm, 230 V, IP44, LED



▶ **81878615**

bílá, plast
 ↑90 Ø260
 12 W/4000 K/800 lm, 230 V, IP44, LED

◀ **82286704**

bílá, plast/kov
 ↑105 Ø325
 18 W/4000 K/1200 lm, 230 V, IP44, LED





◀ **81878618**

bílá, plast/kov
 ↑105 Ø325
 18 W/4000 K/1200 lm, 230 V, IP44, LED



▶ **82390226**

bílá, plast
 ↑110 Ø380
 24 W/4000 K/1600 lm, 230 V, IP44, LED

▲ **82286705**

bílá, plast
 ↑110 Ø380
 24 W/4000 K/1600 lm, 230 V, IP44, LED

Vše skladem





◀ 81797657

bílá, plast
↑49 Ø 278
18 W/3000 K/1620 lm, 230 V, IP54, LED
A++ A LED

◀ 81797656

bílá, plast
↑49 Ø 278
18 W/4000 K/1700 lm, 230 V, IP54, LED
A++ A LED

▶ 82382816

bílá, plast
↑49 Ø 278
18 W/4000 K/1700 lm, 230 V, IP54, LED

A++ A LED



Vše skladem



◀ 81797660

bílá, plast/kov
↑49 Ø 327
24 W/4000 K/2280 lm, 230 V, IP54, LED
A++ A LED

▲ 81797661

bílá, plast
↑49 Ø 327
24 W/3000 K/2160 lm, 230 V, IP54, LED
A++ A LED

▲ 82298749

bílá, plast
↑49 Ø 327
24 W/4000 K/2280 lm, 230 V, IP54, LED

A++ A LED



▶ **82286476**

bílá, plast
 ↑49 →278 ↗278
 18 W/4000 K/1700 lm, 230 V, IP54, LED



A++ A LED

▲ **81799415**

bílá, plast
 ↑49 →278 ↗278
 18 W/3000 K/1620 lm, 230 V, IP54, LED

A++ A LED

▲ **81799416**

bílá, plast
 ↑49 →278 ↗278
 18 W/4000 K/1700 lm, 230 V, IP54, LED

A++ A LED



Vše skladem



◀ **82291102**

bílá, plast
 ↑49 →327 ↗327
 24 W/4000 K/2280 lm, 230 V, IP54, LED



A++ A LED

▲ **81799413**

bílá, plast
 ↑49 →327 ↗327
 24 W/3000 K/2160 lm, 230 V, IP54, LED

A++ A LED

▲ **81799414**

bílá, plast
 ↑49 →327 ↗327
 24 W/4000 K/2280 lm, 230 V, IP54, LED

A++ A LED

▼ **81765003**

bílá, plast/kov
 ↑120 Ø400
 24 W/4000 K/1920 lm, 230 V, IP44, LED



▼ **81765001**

bílá, plast/kov
 ↑120 Ø400
 24 W/3000 K/1920 lm, 230 V, IP44, LED

▼ **81765000**

bílá, plast/kov
 ↑120 Ø400
 24 W/3000 K/1920 lm, 230 V, IP44, LED

▼ **82684003**

bílá, plast/kov
 ↑120 Ø400
 24 W/4000 K/1920 lm, 230 V, IP44, LED

▼ **81764998**

bílá, plast/kov
 ↑115 Ø350
 18 W/3000 K/1440 lm, 230 V, IP44, LED

▼ **81764999**

bílá, plast/kov
 ↑115 Ø350
 18 W/4000 K/1440 lm, 230 V, IP44, LED



▲ **82496899**

bílá, plast/kov
 ↑115 Ø350
 18 W/3000 K/1440 lm, 230 V, IP44, LED

Vše skladem



▲ **81896973**

bílá, plast/kov
 ↑91 Ø250
 13 W/3000 K/920 lm, 230 V, IP44, LED



▲ **81896976**

bílá, plast/kov
 ↑91 Ø250
 13 W/4000 K/960 lm, 230 V, IP44, LED

▲ **82399019**

bílá, plast/kov
 ↑91 Ø250
 13 W/3000 K/920 lm, 230 V, IP44, LED

▲ **81896979**

bílá, plast/kov
 ↑91 Ø250
 13 W/4000 K/960 lm, 230 V, IP44, LED

▶ **81188681**

bílá/matná, sklo/plast
 ↑85 Ø 240
 100 W, 230 V, IP44, E27
 A++ E



Vše skladem



◀ **81699586**

bílá, plast
 Ø 275
 18 W/3000 K/970 lm, 230 V, IP44, LED



A++ LED



◀ **81699589**

bílá, plast
 Ø 275
 18 W/4100 K/970 lm, 230 V, IP44, LED



A++ LED

▶ **81188684**

bílá, sklo/plast
 ↑110 Ø 300
 60 W, 230 V, IP44, E27



A++ E



▶ **81188685**

stříbrná, sklo/plast
 ↑110 Ø 300
 60 W, 230 V, IP44, E27



A++ E

▶ **254171**

bílá, opálové sklo/kov
 ↑110 Ø220
 60 W, 230 V, IP43, E27



A++ E



◀ **74997313**

bílá, opálové sklo/kov
 ↑120 Ø280
 2x 60 W, 230 V, IP43, E27



A++ E



◀ **40991740**

bílá, opálové sklo/kov
 ↑120 Ø350
 2x 75 W, 230 V, IP43, E27



A++ E

▶ **445587**

bílá, opálové sklo/kov
 ↑125 Ø420
 2x 75 W, 230 V, IP43, E27



A++ E



▶ **81782976**

bílá, opálové sklo/kov
 ↑120 Ø280
 11 W/ 4000 K/1350 lm, 230 V, IP43, LED



A++ LED



▲ **80992008**

bílá, opálové sklo/kov
 ↑110 Ø250
 75 W, 230 V, IP44, E27

A++ E



◀ **58411**

bílá, opálové sklo/kov
 ↑130 Ø490
 3x 60 W, 230 V, IP43, E27



A++ E



◀ **43995200**

bílá, opálové sklo/kov
 ↑140 Ø590
 3x 75 W, 230 V, IP43, E27



A++ E

▶ **40991054**

bílá/čirá, polykarbonát
 ↑105 Ø 210
 60 W, 230 V, IP54, E27

A++ E

▶ **74997157**

bílá/čirá, polykarbonát
 ↑110 Ø 260
 100 W, 230 V, IP65, E27

A++ E

▶ **844201**

bílá/čirá, polykarbonát
 ↑120 Ø 310
 2x 60 W, 230 V, IP65, E27

A++ E

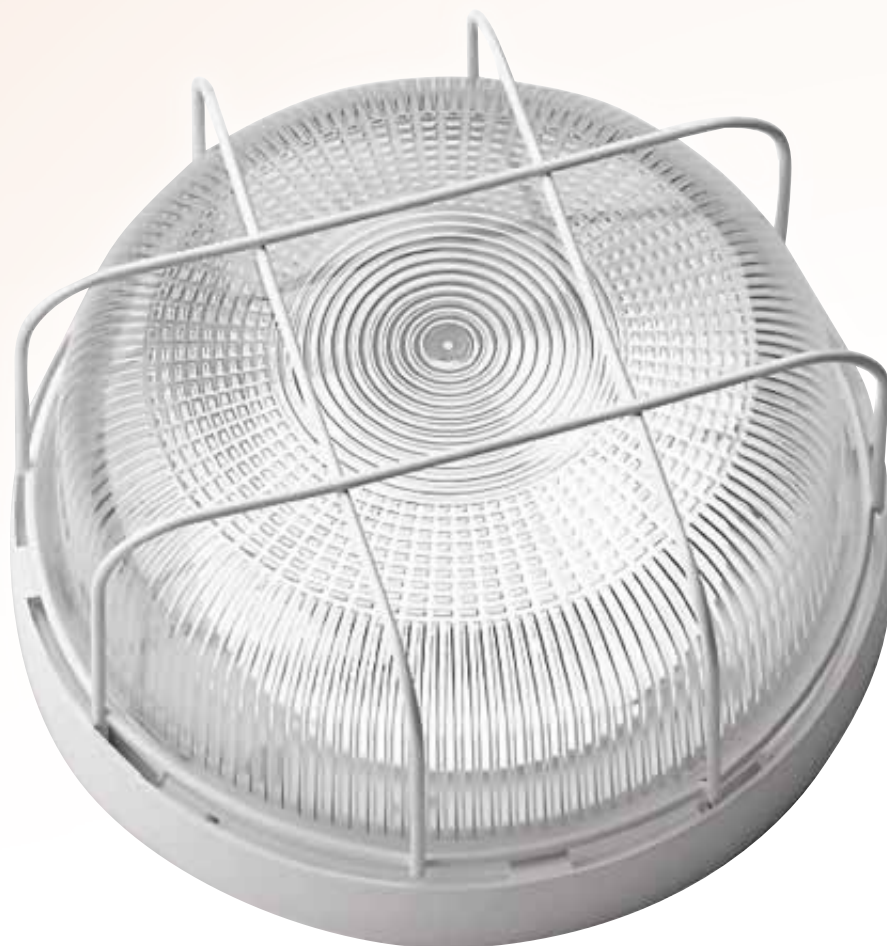

Vše skladem



◀ **58222**

bílá/čirá, polykarbonát
 ↑100 Ø 320
 100 W, 230 V, IP65, E27

A++ E

Vše skladem



◀ 82197711

bílá, polykarbonát/tvrzené sklo
 ↑125 →115 ↗39
 10 W/4000 K/1100 lm, 230 V, IP65, LED
 A+ LED



◀ 82196928

černá, polykarbonát/tvrzené sklo
 ↑125 →115 ↗39
 10 W/3000 K/1050 lm, 230 V, IP65, LED
 A+ LED

◀ 82197710

bílá, polykarbonát/tvrzené sklo
 ↑125 →115 ↗39
 10 W/3000 K/1050 lm, 230 V, IP65, LED
 A+ LED

▲ 82197710

černá, polykarbonát/tvrzené sklo
 ↑125 →115 ↗39
 10 W/4000 K/1100 lm, 230 V, IP65, LED
 A+ LED



▼ 82290094

černá, polykarbonát/tvrzené sklo
 ↑251 →216 ↗122
 50 W/3000 K/5500 lm, 230 V, IP65, LED

 A+ LED

▲ 82289896

černá, polykarbonát/tvrzené sklo
 ↑223,5 →167 ↗104
 20 W/3000 K/2200 lm, 230 V, IP65, LED

 A+ LED

▲ 82196151

černá, polykarbonát/tvrzené sklo
 ↑223,5 →167 ↗104
 20 W/4000 K/2200 lm, 230 V, IP65, LED

 A+ LED



◀ 82196930

černá, polykarbonát/tvrzené sklo
 ↑251 →216 ↗122
 50 W/4000 K/5500 lm, 230 V, IP65, LED

 A+ LED

▶ **82197713**

bílá, polykarbonát/tvrzené sklo
 ↑130 →140 ↗41
 20 W/3000 K/2100 lm, 230 V, IP65, LED



A+ LED

▶ **82097623**

bílá, polykarbonát/tvrzené sklo
 ↑130 →140 ↗41
 20 W/4000 K/2200 lm, 230 V, IP65, LED



A+ LED

▶ **82196929**

bílá, polykarbonát/tvrzené sklo
 ↑130 →140 ↗41
 20 W/6500 K/2200 lm, 230 V, IP65, LED

A+ LED



◀ **82197712**

černá, polykarbonát/tvrzené sklo
 ↑130 →140 ↗41
 20 W/3000 K/2100 lm, 230 V, IP65, LED



A+ LED

◀ **81778549**

černá, polykarbonát/tvrzené sklo
 ↑130 →140 ↗41
 20 W/4000 K/2200 lm, 230 V, IP65, LED



A+ LED

◀ **82391090**

černá, polykarbonát/tvrzené sklo
 ↑130 →140 ↗41
 20 W/6500 K/2200 lm, 230 V, IP65, LED

A+ LED



▶ **82396211**

bílá, polykarbonát/tvrzené sklo
 ↑140 →150 ↗42
 30 W/3000 K/3 150 lm, 230 V, IP65, LED



A+ LED

▶ **82387555**

bílá, polykarbonát/tvrzené sklo
 ↑140 →150 ↗42
 30 W/4000 K/3 300 lm, 230 V, IP65, LED



A+ LED





◀ **82394546**

černá, polykarbonát/tvrzené sklo
 ↑140 →150 ↗42
 30 W/3000 K/3150 lm, 230 V, IP65, LED

A+ LED

◀ **82387554**

černá, polykarbonát/tvrzené sklo
 ↑140 →150 ↗42
 30 W/4000 K/3300 lm, 230 V, IP65, LED

A+ LED

▶ **82197716**

bílá, polykarbonát/tvrzené sklo
 ↑155 →180 ↗46
 50 W/3000 K/5250 lm, 230 V, IP65, LED

A+ LED



▶ **81899706**

bílá, polykarbonát/tvrzené sklo
 ↑155 →180 ↗46
 50 W/4000 K/5500 lm, 230 V, IP65, LED

A+ LED



◀ **82197714**

černá, polykarbonát/tvrzené sklo
 ↑155 →180 ↗46
 50 W/3000 K/5250 lm, 230 V, IP65, LED

A+ LED

◀ **81896259**

černá, polykarbonát/tvrzené sklo
 ↑155 →180 ↗46
 50 W/4000 K/5500 lm, 230 V, IP65, LED

A+ LED

Vše skladem





◀ **81758847**

černá, plast/hliník
 ↑82 →108 ↗37
 15 W/4000 K/1500 lm, 230 V, IP65, LED

A+ LED



▶ **81758848**

černá, plast/hliník
 ↑130 →171 ↗40
 30 W/4000 K/3000 lm, 230 V, IP65, LED

A+ LED



◀ **81758849**

černá, plast/hliník
 ↑154 →217 ↗45
 50 W/4000 K/5000 lm, 230 V, IP65, LED

A+ LED

Vše skladem



▶ **81758851**

černá, plast/hliník
 ↑250 →320 ↗86
 100 W/4000 K/10500 lm, 230 V, IP65, LED

A+ LED





◀ **81763313**

šedá, sklo/hliník
 ↑87 →115 ↗90
 10 W/4000 K/1000 lm, 230 V, IP65, LED

A+ LED

Vše skladem



▲ **81763314**

šedá, sklo/hliník
 ↑140 →180 ↗100
 20 W/4000 K/2000 lm, 230 V, IP65, LED

A+ LED



▲ **81763315**

šedá, sklo/hliník
 ↑187 →225 ↗115
 30 W/4000 K/3000 lm, 230 V, IP65, LED

A+ LED

▶ **81763316**

šedá, sklo/hliník
 ↑238 →287 ↗138
 50 W/4000 K/5000 lm, 230 V, IP65, LED

A+ LED





▲ **81766541**

šedá, sklo/hliník
 ↑155 →115 ↗110
 10 W/4000 K/1000 lm, 230 V, IP44, LED



A+ LED



▲ **81769749**

šedá, sklo/hliník
 ↑300 →284 ↗138
 50 W/4000 K/5000 lm, 230 V, IP44, LED



A+ LED



▼ **81769878**

šedá, sklo/hliník
 ↑210 →180 ↗120
 20 W/4000 K/2000 lm, 230 V, IP44, LED



A+ LED

Vše skladem



▲ **81767386**

šedá, sklo/hliník
 ↑240 →225 ↗120
 30 W/4000 K/3000 lm, 230 V, IP44, LED



A+ LED





Série AREL



◀ **82685285**

hnědá/mosaz, dřevo/kov

↑405 Ø 1066

60 W, 230 V, IP20, E27

zpětný chod

3 rychlosti



A++ E





◀ **82685260**

matná černá, kov/ABS
 ↑300 ø 1320
 230 V, IP20
 zpětný chod
 5 rychlostí
 možnost časového nastavení



▶ **82685259**

matná černá, kov/ABS
 ↑330 ø 1320
 18 W/4000 K/2000 lm, 230 V, IP20, LED
 zpětný chod
 5 rychlostí
 možnost časového nastavení



A++ A **LED**



◀ **82685261**

matná bílá, kov/ABS
 ↑330 ø 1320
 18 W/4000 K/2000 lm, 230 V, IP20, LED
 zpětný chod
 5 rychlostí
 možnost časového nastavení



A++ A **LED**



▶ **82685269**

matná bílá, kov/ABS
 ↑300 ø 1320
 230 V, IP20
 zpětný chod
 5 rychlostí
 možnost časového nastavení



◀ **82685271**

matná černá, kov/ABS
 ↑370 ø 1420
 18 W/4000 K/2000 lm, 230 V, IP20, LED
 zpětný chod
 6 rychlostí



A++ A **LED**



▼ **81493199**

matný nikl/javor, dřevo/kov
 ↑390 Ø 810
 40 W, 230 V, IP20, E14
 zpětný chod
 3 rychlosti



► **81493198**

bílá/bílá, dřevo/kov
 ↑390 Ø 810
 40 W, 230 V, IP20, E14
 zpětný chod
 3 rychlosti



▲ **81493200**

tmavě hnědá/magahonová, dřevo/kov
 ↑390 Ø 810
 40 W, 230 V, IP20, E14
 zpětný chod
 3 rychlosti



▲ **81785851**

bílá/barevná, dřevo/kov
 ↑390 Ø 810
 40 W, 230 V, IP20, E14
 zpětný chod
 3 rychlosti



► **81493201**

šedá/šedá, dřevo/kov
 ↑390 Ø 810
 40 W, 230 V, IP20, E14
 zpětný chod
 3 rychlosti



► **82685275**

lesklá bílá/bílá + javor, dřevo/kov
 ↑360 Ø 1066
 60 W, 230 V, IP20, E14
 zpětný chod
 3 rychlosti



A++ E



◀ **81493196**

bílá/bílá, kov
 ↑320 Ø 1200
 230 V, IP20
 zpětný chod
 3 rychlosti
 ovládání na zed'



► **81585816**

tmavě hnědá/rudý magagon + dub, dřevo/kov
 ↑520 Ø 1320
 4x 60 W, 230 V, IP20, E27
 zpětný chod
 3 rychlosti



A++ E



◀ **82685280**

matný nikl/hnědá, dřevo/kov
 ↑406 Ø 1320
 60 W, 230 V, IP20, E27
 zpětný chod
 3 rychlosti



A++ E





◀ **81497884**

mahagon/tmavý ořech + tmavě hnědá, dřevo/kov
 ↑460 Ø 1070
 3× 60 W, 230 V, IP20, E27
 zpětný chod
 3 rychlosti



▶ **81754104**

šedá/borovice + šedá, dřevo/kov
 ↑400 Ø 910
 3× 50 W, 230 V, IP20, GU10
 zpětný chod
 3 rychlosti



◀ **81684522**

tmavě šedá/ořech + rudý ořech, dřevo/kov
 ↑600 Ø 1400
 230 V, IP20
 zpětný chod
 3 rychlosti



▶ **82685442**

matná černá/tmavý dub, dřevo/kov
 ↑515 Ø 1370
 230 V, IP20
 zpětný chod
 3 rychlosti





◀ **82685283**

matný nikl/stříbrná, dřevo/kov
 ↑337 Ø1066
 60 W, 230 V, IP20, E14
 zpětný chod
 3 rychlosti



A++ E

▶ **82685285**

hnědá/mosaz, dřevo/kov
 ↑405 Ø1066
 60 W, 230 V, IP20, E27
 zpětný chod
 3 rychlosti



A++ E



◀ **82685286**

matná černá, dřevo/kov
 ↑515 Ø1370
 230 V, IP20
 zpětný chod
 3 rychlosti



▶ **82685287**

matná bílá, dřevo/kov
 ↑515 Ø1370
 230 V, IP20
 zpětný chod
 3 rychlosti



► **81493197**

bílá/bílá, kov
 ↑483 Ø920
 230 V, IP20
 5 rychlostí
 ovládání na zeď



◀ **81684523**

wenge/ruďý mahagon + hnědá, dřevo/kov
 ↑432 Ø1320
 2x 40 W, 230 V, IP20, E14
 zpěťný chod
 3 rychlosti



► **81754107**

matný nıkl/šedá + mahagon, dřevo/kov
 ↑305 Ø1320
 2x 15 W, 230 V, IP20, E27
 zpěťný chod
 3 rychlosti



◀ **81785864**

bílá, plast
 ↑120 →60 ↗20
 Rádiové dálkové ovláďání 33929 pro stropní ventilátory. Balení obsahuje držák na zeď, vysílač i přijímač, který je nutné nainstalovat do ventilátoru.



◀ **81750932**

bílá, plast
 ↑120 →60 ↗20
 Dálkové ovláďání programovatelné 33937 pro stropní ventilátory. Balení obsahuje držák na zeď, vysílač i přijímač, který je nutné nainstalovat do ventilátoru.



**◀ 82685286**

matná černá, dřevo/kov

↑515 Ø1370

230 V, IP20

zpětný chod

3 rychlosti



POBOČKY ELKOV ELEKTRO

► BLANSKO

Vodní 613/5
678 01 Blansko
tel.: 516 419 533
e-mail: blansko@elkov.cz

Provozní doba:

Po, Út, Čt, Pá: 6³⁰–15¹⁵
St: 6³⁰–16³⁰

► BRNO

Kšírova 701/255
619 00 Brno
tel.: 543 538 850, 547 212 269,
547 212 290
e-mail: brno@elkov.cz

Provozní doba:

Po–Pá: 6³⁰–16³⁰

Samoobslužná prodejna:

Po–Pá: 6³⁰–16³⁰
So: 8⁰⁰–13⁰⁰

► BRNO-ŘEČKOVICE

Gromešova 25
(za budovou AŽD Praha)
621 00 Brno-Řečkovice
tel.: 725 653 273
e-mail: reckovice@elkov.cz

Provozní doba:

Po–Pá: 7⁰⁰–17⁰⁰

► BYSTRICE NAD PERN.

Zahradní 13
(areál Koberce Trend)
593 01 Bystrice nad Pernštejnem
tel.: 725 653 259
e-mail: bystrice@elkov.cz

Provozní doba:

Po–Pá: 7⁰⁰–15³⁰

► ČESKÁ TŘEBOVÁ

Dr. E. Beneše 125
560 02 Česká Třebová
tel.: 777 736 467
e-mail: ceska.trebova@elkov.cz

Provozní doba:

Po–Pá: 7⁰⁰–16⁰⁰

► HOLICE

Hradecká 1118
534 01 Holice
tel.: 602 162 986
e-mail: holice@elkov.cz

Provozní doba:

Po–Pá: 7⁰⁰–11³⁰, 12⁰⁰–15³⁰

► HRADEC KRÁLOVÉ

Vážní 900
500 03 Hradec Králové
tel.: 495 546 900
e-mail: hradec@elkov.cz

Provozní doba:

Po–Pá: 7⁰⁰–16³⁰

► HUSTOPEČE

Nádražní 1412/37D
693 01 Hustopeče
tel.: 519 413 611
e-mail: hustopece@elkov.cz

Provozní doba:

Po–Pá: 6³⁰–16³⁰

► CHOTĚBOŘ

Sokolohradská 1879
583 01 Chotěboř
tel.: 725 653 355
e-mail: chotebor@elkov.cz

Provozní doba:

Po–Pá: 7⁰⁰–15³⁰

► JEVÍČKO

Okružní IV/844
569 43 Jevíčko
tel.: 725 653 286
e-mail: jevicko@elkov.cz

Provozní doba:

Po–Pá: 7⁰⁰–12⁰⁰, 13⁰⁰–16⁰⁰

► KLADNO

Trojanova 124
272 01 Kladno
tel.: 777 001 240
e-mail: kladno@elkov.cz

Provozní doba:

Po–Pá: 7⁰⁰–17⁰⁰ (velkoobchod)
Po–Pá: 7³⁰–17⁰⁰ (maloobchod)
So: 8⁰⁰–12⁰⁰ (maloobchod)

► KROMĚŘÍŽ

Chelčického 1656/1a
767 01 Kroměříž
tel.: 573 342 722
e-mail: kromeriz@elkov.cz

Provozní doba:

Po–Pá: 6³⁰–15³⁰

► LIBEREC

Doubská 1077/55
460 06 Liberec VI - Rochlice
tel.: 488 577 075
e-mail: liberec@elkov.cz

Provozní doba:

Po–Pá: 6³⁰–16⁰⁰

► PARDUBICE

Husova 1576
Bílý Předměstí
530 02 Pardubice
tel.: 466 410 332–33
e-mail: pardubice@elkov.cz

Provozní doba:

Po–Čt: 6³⁰–16⁰⁰
Pá: 6³⁰–15⁰⁰

► PRAHA 4

Severní XI 2458/1
141 00 Praha 4
tel.: 272 657 181
e-mail: praha.sporilov@elkov.cz

Provozní doba:

Po–Čt: 7⁰⁰–16⁰⁰
Pá: 7⁰⁰–15⁰⁰

► PRAHA 9

Náchodská 2604/21a
193 00 Praha 9
tel.: 281 864 482
e-mail: praha.pocernice@elkov.cz

Provozní doba:

Po–Čt: 7⁰⁰–16⁰⁰
Pá: 7⁰⁰–15⁰⁰

► PRAHA 13

K Hájům 1068/4
155 00 Praha 13
tel.: 725 653 388
e-mail: praha.stodulky@elkov.cz

Provozní doba:

Po–Čt: 7⁰⁰–16⁰⁰
Pá: 7⁰⁰–15⁰⁰

► PROSTĚJOV

Plumlovská 481/200
796 04 Prostějov
tel.: 582 334 630
e-mail: prostejov@elkov.cz

Provozní doba:

Po–Pá: 6³⁰–16⁰⁰

► RYCHNOV N. KNĚŽ.

Na Sádkách 1799
516 01 Rychnov nad Kněžnou
tel.: 721 955 145
e-mail: rychnov@elkov.cz

Provozní doba:

Po–Pá: 6³⁰–11³⁰, 12⁰⁰–15⁰⁰

► SOKOLOV

Stará Březovská 2259
356 01 Sokolov
tel.: 725 653 341
e-mail: sokolov@elkov.cz

Provozní doba:

Po–Pá: 7⁰⁰–15³⁰

► SVITAVY

Purkyňova 246/18
568 02 Svitavy
tel.: 777 736 391
e-mail: svitavy@elkov.cz

Provozní doba:

Po–Pá: 6³⁰–15³⁰

Maloprodejna:

Po–Pá: 8⁰⁰–12⁰⁰, 13⁰⁰–17⁰⁰
So: 8⁰⁰–11⁰⁰

► ŠENOV

Dukelská 109
742 42 Šenov u Nového Jičína
tel.: 773 835 508
e-mail: novyjiicin@elkov.cz

Provozní doba:

Po–Pá: 6³⁰–15³⁰

► TIŠNOV

Wagnerova 1715
666 01 Tišnov
tel.: 603 151 502
e-mail: tisnov@elkov.cz

Provozní doba:

Po–Pá: 6³⁰–11³⁰, 12⁰⁰–15³⁰

► VALAŠSKÉ MEZIŘÍČÍ

Zašovská 847
757 01 Valašské Meziříčí
tel.: 725 653 282
e-mail: valaske.mezirici@elkov.cz

Provozní doba:

Po–Pá: 6³⁰–15⁰⁰

▶ **VELKÉ MEZIRÍČÍ**

K Novému nádraží 2260
594 01 Velké Meziříčí
tel.: 566 521 734
e-mail: velke.mezirici@elkov.cz

Provozní doba:
Po–Pá: 6⁰⁰–15³⁰

▶ **VYSOKÉ MÝTO**

nám. Pod Kaštany 938
566 01 Vysoké Mýto
tel.: 725 653 352
e-mail: vysoke.myto@elkov.cz

Provozní doba:
Po–Pá: 6³⁰–11³⁰, 12³⁰–15⁰⁰

▶ **ZÁBŘEH**

Cihlářská 2294/10
789 01 Zábřeh
tel.: 583 416 663
e-mail: zabreh@elkov.cz

Provozní doba:
Po–Pá: 7⁰⁰–16⁰⁰

▶ **ZLÍN**

Chmelník 1296
763 02 Zlín-Malenovice
tel.: 577 110 350–52
e-mail: zlin@elkov.cz

Provozní doba:
Po–Pá: 6³⁰–16⁰⁰

▶ **ŽĎÁR NAD SÁZAVOU**

Brněnská 8
591 01 Žďár nad Sázavou
tel.: 777 736 471
e-mail: zdar@elkov.cz

Provozní doba:
Po–Pá: 6³⁰–16³⁰

Kde nás najdete:

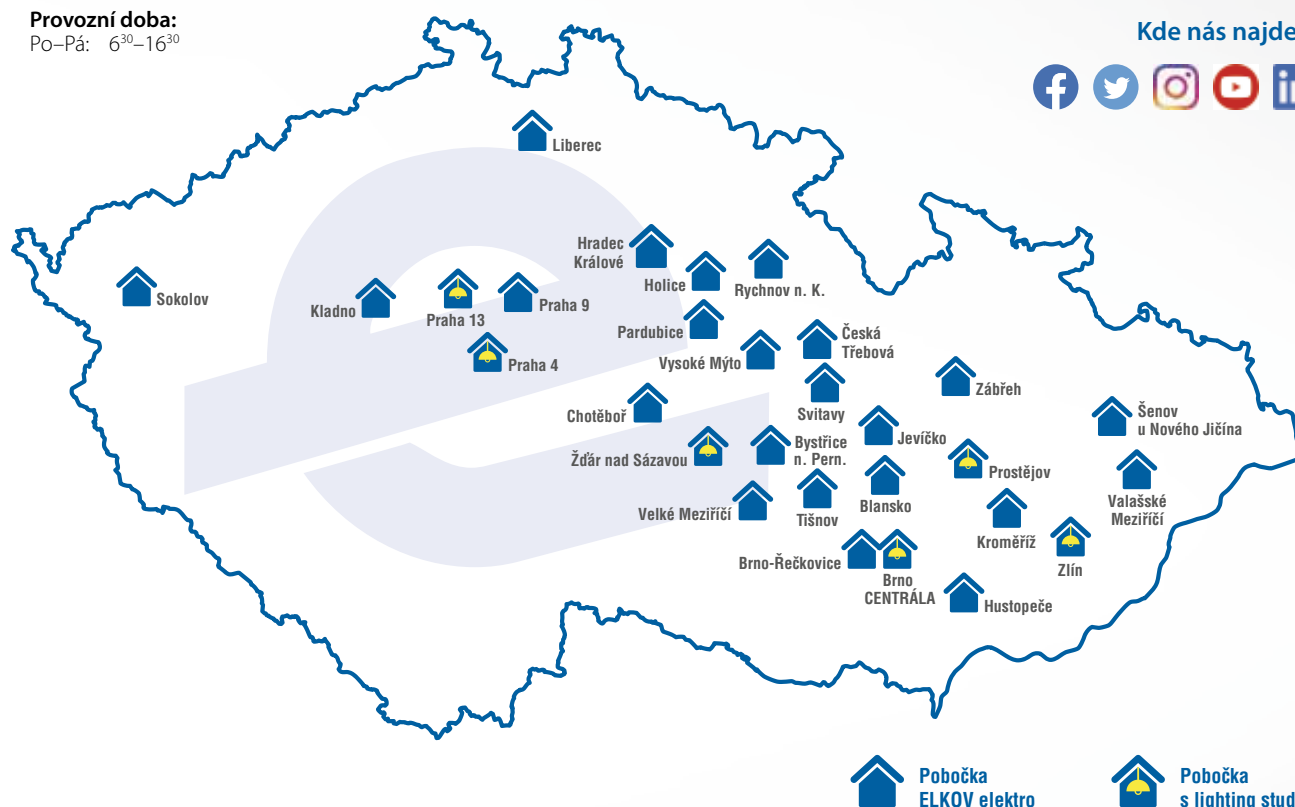

LIGHTING STUDIA

▶ **BRNO**

Sokolova 701/1f
619 00 Brno
tel.: 725 653 309, 725 653 988
e-mail: lightingstudiobrn@elkov.cz

Provozní doba:
Po–Pá: 6³⁰–16³⁰
So: 8⁰⁰–13⁰⁰

▶ **PRAHA 4**

Severní XI 2458/1
141 00 Praha 4
tel.: 725 653 267
e-mail: lightingstudiopraha@elkov.cz

Provozní doba:
Po–Čt: 7⁰⁰–16⁰⁰
Pá: 7⁰⁰–15⁰⁰

▶ **PRAHA 13**

K Hájům 1068/4
155 00 Praha 13
tel.: 725 653 383
e-mail: praha.stodulky@elkov.cz

Provozní doba:
Po–Čt: 7⁰⁰–16⁰⁰
Pá: 7⁰⁰–15⁰⁰

▶ **PROSTĚJOV**

Plumlovská 481/200
796 04 Prostějov
tel.: 725 172 041
e-mail: prostejov@elkov.cz

Provozní doba:
Po–Pá: 6³⁰–16⁰⁰

▶ **ZLÍN**

Chmelník 1296
763 02 Zlín-Malenovice
tel.: 725 653 230, 725 653 248
e-mail: lightingstudiozlin@elkov.cz

Provozní doba:
Po–Pá: 6³⁰–16⁰⁰

▶ **ŽĎÁR NAD SÁZAVOU**

Brněnská 8
591 01 Žďár nad Sázavou
tel.: 733 644 498, 734 600 033
e-mail: lightingstudiozdar@elkov.cz

Provozní doba:
Po–Pá: 8⁰⁰–16³⁰

A series of horizontal dotted lines for writing notes.

Handwriting practice area with horizontal dotted lines.







ELKOV elektro a.s.
Kšírova 701/255
619 00 Brno
tel.: 543 538 850
e-mail: lightingstudio@elkov.cz

www.elkov.cz